

KEEP FOR FUTURE REFERENCE



*P.O. Box 368 – 908 West Main
Laurel, MT USA 59044
phone 800-548-7341
phone 406-628-8231
fax 406-628-8354*

SERVICE MANUAL



STOCK NUMBER 36100

2.5 SCFM NOMINAL AIRFLOW
DUAL VACUUM SYSTEM
DC-VOLTAGE POWER SYSTEM



*READ ALL INSTRUCTIONS AND SAFETY RULES
BEFORE SERVICING THIS LIFTER*



DESIGNED FOR THE TECHNICAL SERVICE PROFESSIONAL

TABLE OF CONTENTS

TABLE OF CONTENTS	1
BEFORE SERVICING LIFTER	2
SERVICE SCHEDULE	2
SERVICE FEATURES	3
BATTERY CHARGER TEST	4
IN-LINE AIR FILTER SERVICE	5
FILTER FUNCTION AND CONDITIONS REQUIRING SERVICE	5
FILTER SERVICE PROCEDURE	5
DYNAFLO DV1034204 PUMP SERVICE	6
CONDITIONS REQUIRING SERVICE	6
REPLACING A DIAPHRAGM	6
REPLACING A GASKET/FLAP VALVES	6
REPLACING A HEAD ASSEMBLY	6
DIGITAL VACUUM SWITCH ADJUSTMENT	7
VACUUM SWITCH FUNCTION	7
ADJUSTMENT PROCEDURE	7
REPLACEMENT PARTS LIST	9
LIMITED WARRANTY	11

BEFORE SERVICING LIFTER



Make sure battery is disconnected before servicing lifter.

Service personnel must read and understand the *OPERATING INSTRUCTIONS* before attempting to service the vacuum lifter. Many of the following discussions assume knowledge of the *OPERATING INSTRUCTIONS* or access to them.

Note: Wiring and/or hose routing diagrams are provided in the final section of this *SERVICE MANUAL* for reference when servicing the lifter or trouble-shooting a deficiency. If necessary, consult the *OPERATING INSTRUCTIONS* to determine which diagrams are applicable to your specific lifter model and any associated options.

SERVICE SCHEDULE

Service must be performed whenever a deficiency is indicated by routine inspections or tests. Follow the Inspection Schedule and Testing Schedule as directed in the MAINTENANCE section of the *OPERATING INSTRUCTIONS*. Any service warranted must be performed before resuming normal operation of the lifter.

SERVICE FEATURES

Note: Components shown here are underlined> on their first appearance in each section to follow.

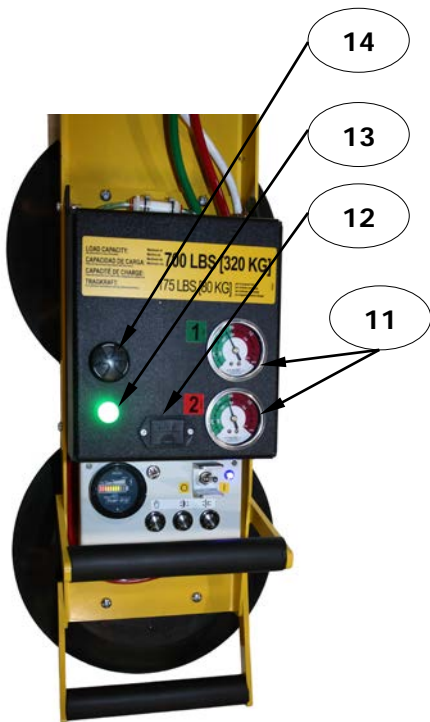
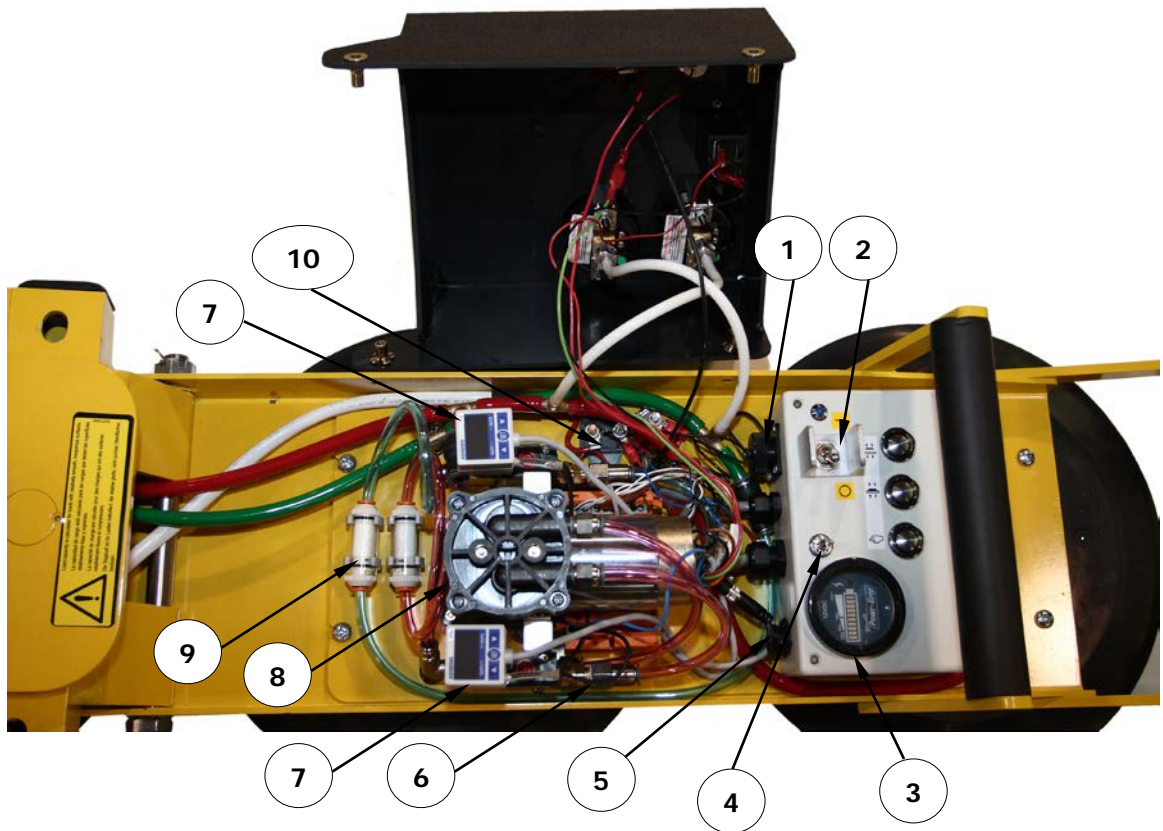

- 1 OPTIONAL REMOTE CONTROL CONNECTOR
- 2 POWER SWITCH
- 3 BATTERY GAUGE
- 4 BATTERY TEST SWITCH
- 5 OPTIONAL STROBE LIGHT CONNECTOR
- 6 CHECK VALVE
- 7 VACUUM SWITCHES
- 8 VACUUM PUMP
- 9 AIR FILTER
- 10 CIRCUIT BREAKER
- 11 VACUUM GAUGES
- 12 POWER LOSS WARNING BATTERY HOLDER
- 13 VACUUM LIFT LIGHT
- 14 LOW VACUUM/POWER LOSS WARNING BUZZER

BATTERY CHARGER TEST

If you suspect the battery charger is not working correctly, this test allows you to determine whether to replace it. Perform this test only when the battery is *not* fully charged (see BATTERY TEST in MAINTENANCE section of *OPERATING INSTRUCTIONS*). While the lifter's power switch is in the OFF position () and the battery charger is *disconnected* from any AC power source, use the battery test switch to take an energy reading on the battery gauge. Then plug the charger in to an appropriate AC power source and allow a few moments for the battery gauge to show an accurate energy reading. If the charger is functioning correctly, the energy reading should be higher when the charger is plugged in. If the charger is not functioning correctly, replace it according to the wiring diagram provided.

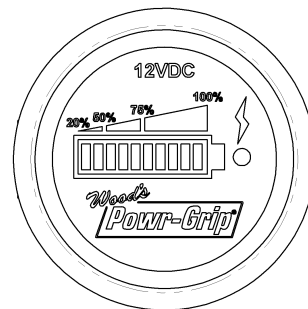

If the charger is

IN-LINE AIR FILTER SERVICE

FILTER FUNCTION AND CONDITIONS REQUIRING SERVICE

This air filter prevents solid particles from contaminating components in the vacuum system.

Caution: *Examine air filter regularly and empty when necessary.*

Open each filter regularly to determine whether liquid or other contaminants are trapped inside. Remove any liquid or contaminants found. Clean or replace the filter element if it has an overall dirty appearance, or if there is a noticeable increase in the time required to attain full vacuum (see REPLACEMENT PARTS LIST).

FILTER SERVICE PROCEDURE

- 1) Hold the filter case (1) and turn the removable end (2) counter-clockwise approximately 45° until it stops moving.
- 2) Pull the end outward from the case and remove the filter element (3). Use an air hose or other suitable means to remove any liquid or other contaminants found inside the case. Also make sure the seal (4) is not damaged.
- 3) Determine whether the filter element needs to be replaced (see CONDITIONS REQUIRING SERVICE above).
- 4) Depending on the outcome of step 3, install a new element or reinstall the old element, as shown in the illustration.
- 5) Align the 2 projections on the removable end with the grooves in the case, and insert the end into the case. Push in and turn the end clockwise approximately 45° until it stops moving. Make sure that the projections are completely visible through the windows (5) in the case.
- 6) Test the vacuum system, to make sure the air filter does not leak (see VACUUM TEST in OPERATING INSTRUCTIONS).

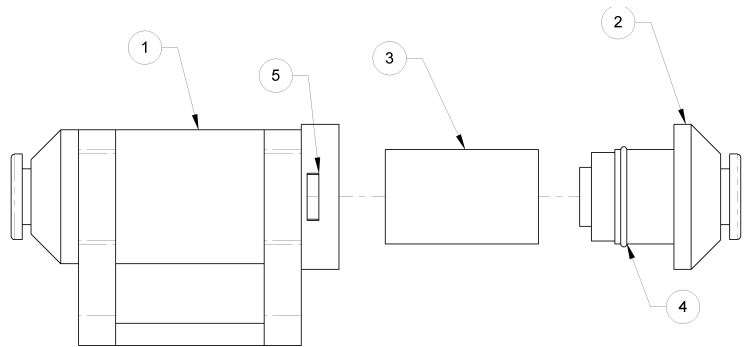

DYNAFLO DV1034204 PUMP SERVICE

CONDITIONS REQUIRING SERVICE



Before performing any service, disconnect power source.

If the vacuum pump takes too long to attain full vacuum, it may require service. Replace the diaphragms, gaskets/flap valves or (when preferable) the entire head assemblies¹, as necessary to obtain acceptable pump performance (see REPLACEMENT PARTS LIST). Perform the following service on both heads of the pump.

Caution: *Do not over-tighten the head screws, because this may damage the threads in the pump body.*

REPLACING A DIAPHRAGM

- 1) Remove the four head screws (1) and lock washers (2), and remove the head assembly (3–7).
- 2) Remove the diaphragm retaining screw (8), diaphragm (9) and rubber O-ring (10).

Note: Be sure to save the flat washer located between the O-ring and the connecting rod (11). Also take note of the diaphragm orientation for reassembly.

- 3) Replace the diaphragm, rubber O-ring and diaphragm retaining screw. Reinstall the flat washer in its original position.
- 4) Reverse the steps above for reassembly, as shown in the illustration.

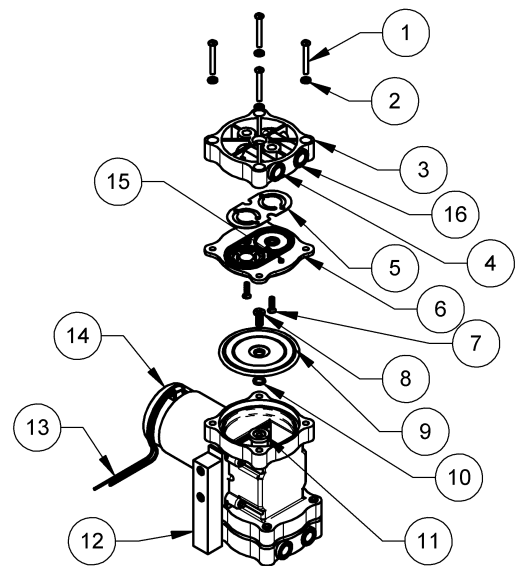

1 HEAD SCREW	5 GASKET/FLAP VALVES	9 DIAPHRAGM	13 WIRES
2 LOCK WASHER	6 VALVE PLATE	10 RUBBER O-RING	14 MOTOR
3 HEAD	7 VALVE PLATE SCREW	11 CONNECTING ROD	15 ALIGNMENT PIN
4 INTAKE PORT (VACUUM)	8 DIAPHRAGM RETAINING SCREW	12 MOUNTING FOOT	16 EXHAUST PORT (PRESSURE)

REPLACING A GASKET/FLAP VALVES

- 1) Remove the four head screws (1) and lock washers (2), and remove the head assembly (3–7).
- 2) Invert the head and remove the two valve plate screws (7). Remove the valve plate (6) to access the gasket/flap valves.
- 3) Replace the gasket/flap valves (5) and reverse the steps above for reassembly, as shown in the illustration. Use the alignment pin (15) to ensure proper fit between the head and valve plate.

REPLACING A HEAD ASSEMBLY

- 1) Remove the four head screws (1), lock washers (2) and head assembly (3–7).
- 2) Replace the head assembly, and reverse the steps above for reassembly, as shown in the illustration.

¹ **Caution:** Depending on the product, the head assembly (3–7) may be rotated to an orientation different from the one shown. When removing the head assembly, always take note of its orientation and install it the same way during reassembly.

DIGITAL VACUUM SWITCH ADJUSTMENT

VACUUM SWITCH FUNCTION

Two vacuum switches control various functions of the vacuum lifter (see SERVICE FEATURES for location of vacuum switches). While the lifter is powered up, each vacuum switch senses the vacuum level in one of the two vacuum circuits of the vacuum system. If either circuit loses significant vacuum while the lifter is in the apply mode, the system responds automatically. Each vacuum switch controls two functions: Settings n_1 and n_2 control the vacuum pump(s) and the battery gauge. Settings n_3 and n_4 control a vacuum lift light and low vacuum warning buzzer, light and/or strobe light.

Both vacuum switches should have the same settings to ensure the two circuits are functioning together. Although the vacuum switches are set at the factory and should not require adjustment, the following section lists the factory settings, in case adjustment is necessary.

ADJUSTMENT PROCEDURE

 *Lifting capacity decreases whenever vacuum switch is adjusted to maintain lower vacuum level.*

- 1) To unlock the vacuum switch settings, press and hold the "SET" button for at least five seconds. Note that a different menu may appear if the button is released too soon.² Use the arrow keys to access the unlocked mode ("UnL") and press the "SET" button again.
- 2) Press and release the "SET" button to access the different vacuum switch settings (n_1, n_2, n_3, n_4). Use the arrow keys to adjust each setting and then press the "SET" button to continue to the next setting. The following values should appear on the digital display:
 - n_1 = -458. This setting turns off power to the vacuum pump(s) when the vacuum system reaches the maximum vacuum level. Setting n_1 must always be set above n_2.

Note: Lowering this value allows the pump(s) to shut off at higher elevations, but it also requires the pump(s) to run more frequently.

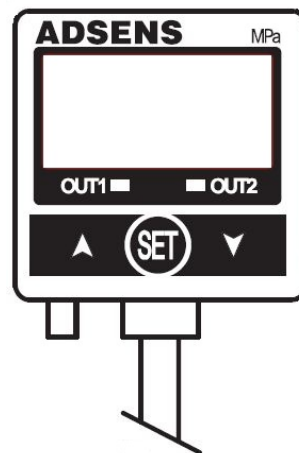

² The vacuum switch has additional settings that should *not* be adjusted. These settings are accessed if the "SET" button is held for 3 seconds. For reference, the correct settings are provided below.

- Setting 1 should display "nnH"
- Setting 2 should display "1nC"
- Setting 3 should display "2nC"
- Setting 4 should display "192"
- Setting 5 should display "nAn"

- n_2 = -432. After a vacuum switch has turned off the vacuum pump(s) (see n_1) and the vacuum system begins to lose vacuum, setting n_2 turns on power again to the vacuum pump(s). The vacuum pump(s) should turn on before the needle on either vacuum gauge moves from the green range to the red range. Setting n_2 must always be set above n_4.
- n_3 = -429. This setting turns off the low vacuum warning buzzer, light and/or strobe light and turns on the vacuum lift light, indicating that the lifter has already reached the minimum vacuum level (see n_4). Setting n_3 must always be set above n_4.
- n_4 = -427. After the vacuum switch has turned off the vacuum pump(s) (see n_1) and the vacuum system has lost significant vacuum, setting n_4 turns on the low vacuum warning buzzer, light and/or strobe light and turns off the vacuum lift light. This signals a loss of adequate vacuum to the lifter operator.

Note: Setting n_4 corresponds with the minimum vacuum level for lifting loads. ***This setting must not be lowered without first consulting Wood's Powr-Grip, because it may reduce the maximum lifting capacity.***

- 3) Each vacuum switch must be locked after all adjustments have been made. Use the arrow keys to access the locked mode ("LoC") and press the "SET" button again.
- 4) Repeat steps 1-4 for the other vacuum switch, to ensure the settings are the same.

REPLACEMENT PARTS LIST

Stock No.	Description	Qty.
93221	Vacuum Pump - Diaphragm Type - 2.5-SCFM [71 liters/minute] - 12 V DC (DynaFlo)	1
66197BM	DynaFlo Pump Gasket & Flap Valves	2
66197AM	DynaFlo Pump Diaphragm Kit	2
66197AA	DynaFlo Pump Dual-Head Assembly	2
65442CA	Vacuum Hose - 1/4" [6.3 mm] OD - Red	A/R
65442BB	Vacuum Hose - 1/4" [6.3 mm] ID x 8" [20 cm] Length - Coiled - Green	A/R
65442AM	Vacuum Hose - 1/4" [6.3 mm] ID x 48" [122 cm] Length - Coiled - Green	A/R
65441	Vacuum Hose - 1/4" [6.3 mm] ID x 48" [122 cm] Length - Coiled - Red	A/R
65439AM	Vacuum Hose - 5/32" [4.0 mm] OD - Red	A/R
65439	Vacuum Hose - 5/32" [4.0 mm] OD - Blue	A/R
65429	Vacuum Hose - 1/4" [6.3 mm] OD - Blue	A/R
65254	Solenoid valve	2
65211	Check Valve - 1/8 NPT	2
64834	LED Indicator - 12 V DC - Green (aka, vacuum lift light)	1
64832	LED Indicator - 12 V DC - Blue - Small (aka, power light)	1
64752	Audio Alarm - 5-15 V DC - Panel Mount	1
64716	Battery Charger - 0.8 Amp - 240 V AC - Australian Type	1
64715	Battery Charger - 0.8 Amp - 240 V AC	1
64714	Battery Charger - 0.8 Amp - 100 / 120 V AC	1
64713AM	Battery Charger - 7 Amp - 240 V AC - Australian Type (optional)	1
64712AM	Battery Charger - 7 Amp - 100 / 120 V AC (optional)	1
64711AM	Battery Charger - 7 Amp - 240 V AC (optional)	1
64665	Battery - 12 V DC - 18 Amp-Hours (optional)	1
64664	Battery - 12 V DC - 7 Amp-Hours	1
64590	Battery Gauge	1
64460	Circuit Breaker - 15 A	1
—	Circuit Board - Populated	1
64238AA	Vacuum Switch - Digital	2
64234AM	Power Switch	1
64213	Push-Button Switch - Chrome (for apply, enable, and release buttons)	3
64209	Momentary Switch (for battery test switch)	1
59086	Battery Connector - Twin Lead - Comfort Connect	1
54392	Battery Connector - Twin Lead	1
16131	Element for Air Filter	2
15920	Vacuum Gauge - 1/8 NPT - CBM Type - w/Panel Mount Bracket	2

***SERVICE ONLY WITH IDENTICAL REPLACEMENT PARTS,
AVAILABLE AT WPG.COM OR THROUGH AN AUTHORIZED WPG DEALER***

LIMITED WARRANTY

Powr-Grip products are carefully constructed, thoroughly inspected at various stages of production, and individually tested. They are warranted to be free from defects in workmanship and materials for a period of one year from the date of purchase.

If a problem develops during the warranty period, follow the instructions hereafter to obtain warranty service. If inspection shows that the problem is due to defective workmanship or materials, Powr-Grip will repair the product without charge.

WARRANTY DOES NOT APPLY WHEN:

Modifications have been made to the product after leaving the factory.

Rubber portions have been cut or scratched during use.

Repairs are required due to abnormal wear and tear.

The product has been damaged, misused, or neglected.

If a problem is not covered under warranty, Powr-Grip will notify the customer of costs prior to repair. If the customer agrees to pay all repair costs and to receive the repaired product on a C.O.D. basis, Powr-Grip then will proceed with repairs.

TO OBTAIN REPAIRS OR WARRANTY SERVICE

For purchases in *North America*:

Contact the Technical Service Department at Wood's Powr-Grip Co. When factory service is required, ship the complete product—prepaid—along with your name, address and phone number to the street address hereafter.

For purchases in *all other localities*:

Contact your dealer or the Technical Service Department at Wood's Powr-Grip Co. for assistance.

Wood's Powr-Grip Co., Inc.
908 West Main St. / P.O. Box 368
Laurel, MT USA 59044

phone 800-548-7341

phone 406-628-8231

fax 406-628-8354

DIRECTORY: \\Rodney\design\Working\STDV7713-RC\ECN 3142
713-W01 [W07]

TYPE: STANDARD

WIRE LEGEND: CONTROLLED BY WIRING SYMBOLS DRAWING EXCEPT AS NOTED AND BELOW. LINE STYLES AND WIDTHS FOR WIRE UNLESS NOTED OTHERWISE.

WOOD'S POWR-GRIP CO., INC.
LAUREL, MONTANA U.S.A.

RADIO REMOTE CONTROL
WIRING DIAGRAM FOR CONTROL ENCL W/ POWER LOSS WARNING
D713-W01 [W07]

DATE: 06/06/2012
PRODUCT MANAGER: NATHAN G.
CHECKED: CR
APPROVED: *Om*

SIZE: SCALE: A NONE
REV: ECN NUMBER: 0 3142
DATE: 05/20/2013
BY: RAS
EST. WEIGHT: N/A

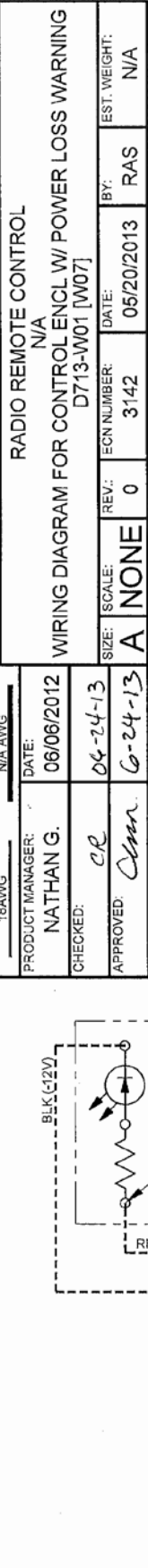

NOTES:
1) SINGLE GOLD OR (+) POSITIVE MARKED TERMINAL.
2) TERMINAL #1 IS THE TERMINAL WITH A DOT BY IT.

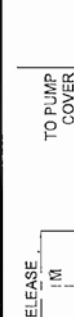

WIRE LEGEND: CONTROLLED BY WIRING SYMBOLS DRAWING EXCEPT AS NOTED AND BELOW. --- 16AWG --- --- 20AWG --- --- N/A --- --- N/A ---		TYPE: STANDARD DIRECTORY: 713-W07 [W07]
PRODUCT MANAGER: NATHAN G. DATE: 03/04/2013		THIS DRAWING IS THE PROPERTY OF WOOD'S POWR-GRIP CO., INC. IT IS LOANED WITH THE UNDERSTANDING THAT NEITHER IT NOR ANY INFORMATION CONTAINED THEREIN WILL BE COPIED, PUBLISHED OR TRANSMITTED TO OTHERS WITHOUT EXPRESS WRITTEN PERMISSION. LAUREL, MONTANA U.S.A.
CHECKED: <i>CR</i>	DATE: <i>01-05-15</i>	RADIO REMOTE CONTROL SYSTEM N/A STROBE LIGHT WIRING DIAGRAM D713-W07 [W07]
APPROVED: <i>OMP</i>	DATE: <i>1-5-15</i>	SIZE: A NONE SCALE: 2 REV: 2 ECN NUMBER: 3595 BY: DTM DATE: 11/05/2014 EST. WEIGHT: N/A

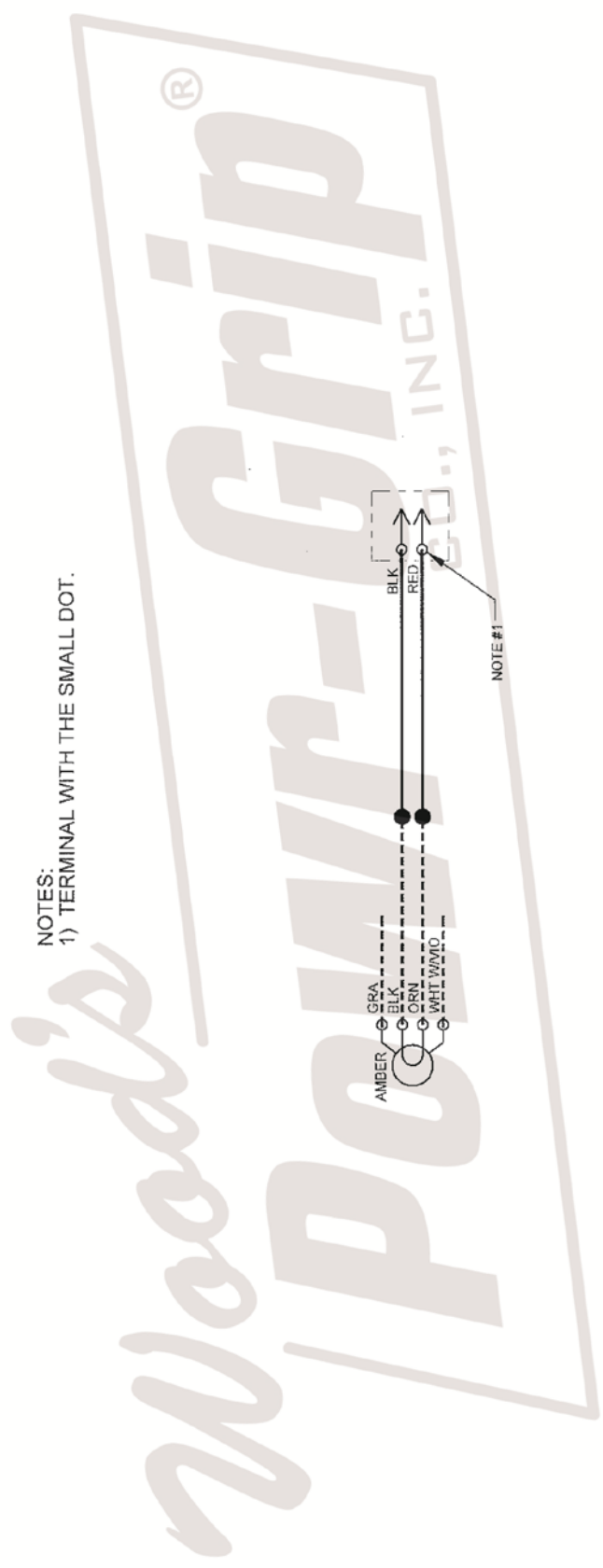

NOTES:
 1) TERMINAL WITH THE SMALL DOT.



TYPE: STANDARD	DIRECTORY:	H:\Working\STDYV740-PC\ECN 3148\
	FILE (SHEET):	740A-W01 [A-W01]
WIRE LEGEND: CONTROLLED BY WIRING SYMBOLS DRAWING EXCEPT AS NOTED AND BELOW. LINE STYLES AND WIDTHS FOR WIRE UNLESS NOTED OTHERWISE. --- 24 AWG --- 20 AWG --- 18 AWG --- 16 AWG	THIS DRAWING IS THE PROPERTY OF WOOD'S POWR-GRIP CO., INC. IT IS LOANED WITH THE UNDERSTANDING THAT NEITHER IT NOR ANY INFORMATION CONTAINED THEREIN WILL BE COPIED, PUBLISHED OR TRANSMITTED TO OTHERS WITHOUT EXPRESS WRITTEN PERMISSION. WOOD'S POWR-GRIP CO., INC. LAUREL, MONTANA U.S.A.	
	PRODUCT MANAGER: KEITH B.	DATE: 05/28/2013
CHECKED: <i>CR</i>	DATE: 05/28/2013	
APPROVED: <i>Out</i>	DATE: 05/28/2013	
SIZE: A	SCALE: NONE	REV: 0
	ECN NUMBER: 3148	DATE: 05/28/2013
	BY: RAS	EST. WEIGHT: N/A

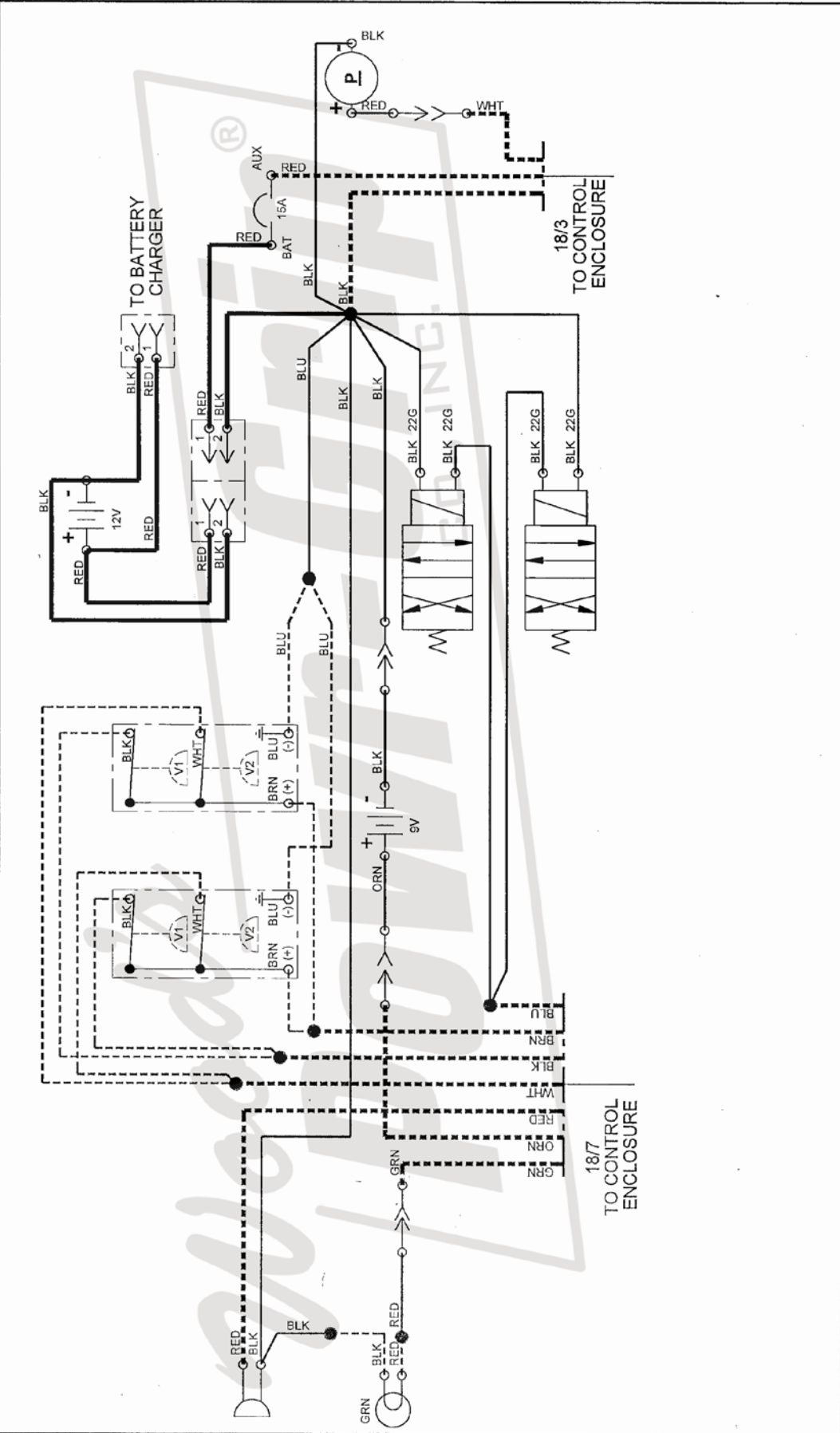

DIRECTORY: H:\Working\STD\740-PC\ECN 3148\ 740A-W02 [A-W02]

TYPE: STANDARD

TOLERANCES: CONTROLLED BY STANDARD D105C001 EXCEPT AS NOTED AND LISTED BELOW.

DECIMAL: X.XX ±N/A
 ANGULAR: X° ±N/A
 FRACTIONAL: X/XX ±N/A
 φ: 1"± φ X/XX ±N/A
 φ: .1"± φ X/XX ±N/A
 UNITS: INCHES (MILLIMETERS). DO NOT SCALE

THIS DRAWING IS THE PROPERTY OF WOOD'S POWR-GRIP CO., INC. LAUREL, MONTANA U.S.A.
 IT IS LOANED WITH THE UNDERSTANDING THAT NEITHER IT NOR ANY INFORMATION CONTAINED THEREIN WILL BE COPIED, PUBLISHED OR TRANSMITTED TO OTHERS WITHOUT EXPRESS WRITTEN PERMISSION.

PAD CHANNEL
 DUAL VACUUM SYSTEM
 PNEUMATIC SCHEMATIC
 D740A-W02 [A-W02]

PRODUCT MANAGER: KEITH B.
 DATE: 05/28/2013
 CHECKED: CR
 APPROVED: CM

SIZE: A NONE
 SCALE: NONE
 REV: 0
 ECN NUMBER: 3148
 DATE: 05/28/2013
 BY: RAS
 EST. WEIGHT: N/A

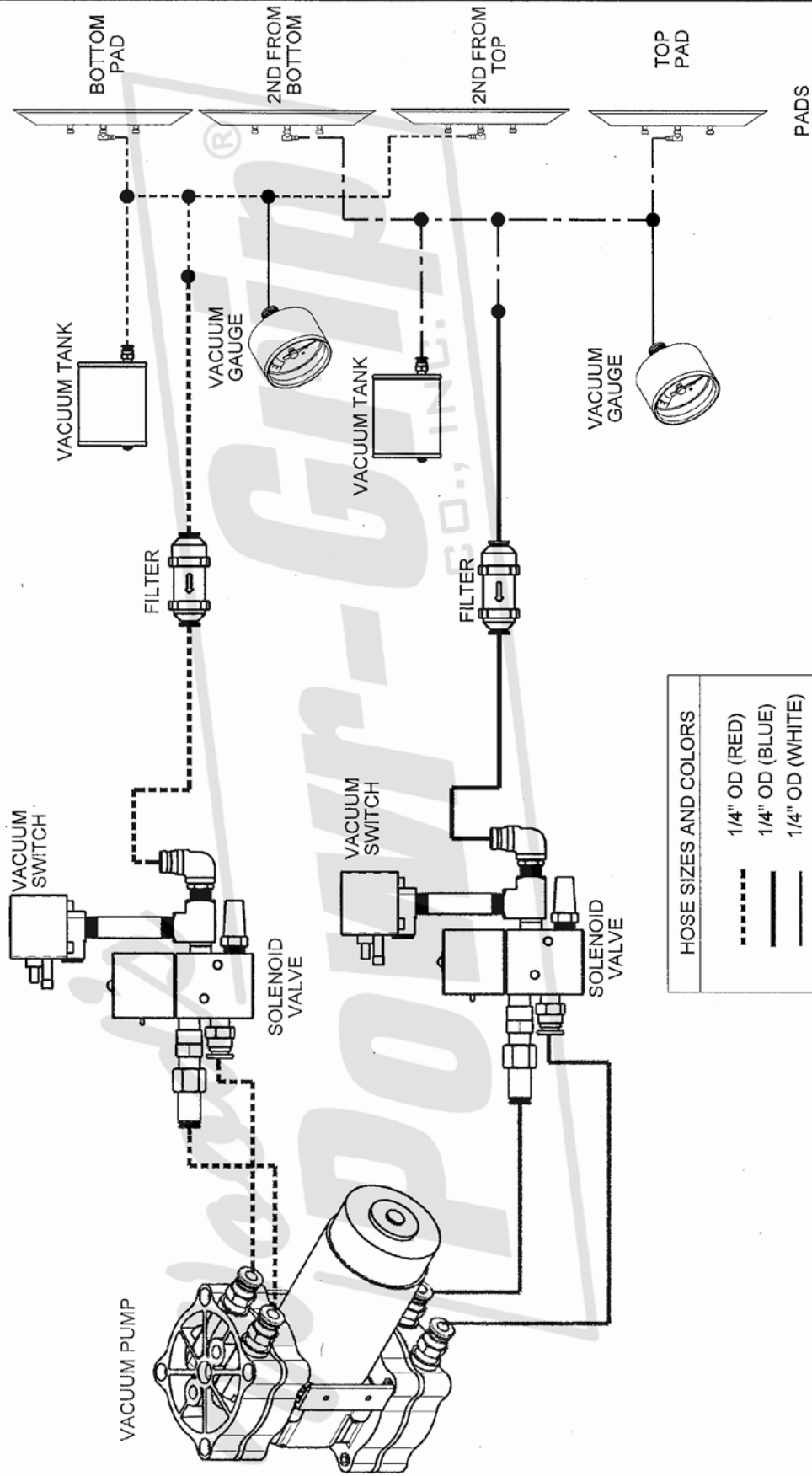

HOSE SIZES AND COLORS	
-----	1/4" OD (RED)
—————	1/4" OD (BLUE)
—————	1/4" OD (WHITE)
-----	3/8" OD (GREEN)
-----	3/8" OD (RED)

1578100

H:\Working\STDV775-MRTAL\PIECN 2976

775B-W01 [C-W01]

WOOD'S POWR-GRIP CO., INC.
LAUREL, MONTANA, U.S.A.

1100# LOW-PROFILE MANUAL ROTATOR/QUADRA-FILTER
CROSS-ARM PAD FRAME
WIRING SCHEMATIC
D775B-W01 [C-W01]

TYPE: STANDARD	DIRECTORY: FILE (SHEET):	REV.: 0	DATE: 09/13/2012
WIRE LEGEND: CONTROLLED BY WIRING SYMBOLS DRAWING EXCEPT AS NOTED AND BELOW. LINE STYLES AND WIDTHS FOR WIRE UNLESS NOTED OTHERWISE. --- 24 AWG --- 19 AWG --- 14 AWG	DRAWN: R. SCHNEIDER CHECKED: <i>CR</i> APPROVED: <i>Man</i>	ECN NUMBER: 2976	BY: RAS
DATE: 09/13/2012	DATE: 12-05-12	SCALE: A	EST. WEIGHT: N/A
DATE: 12-05-12	DATE: 12-06-12	REV.: 0	

NOTES:
1) SOLDER RED(+) LINE OF STROBE LIGHT TO THE TERMINAL WITH A DOT BY IT.

