

INTENDED FOR USE BY PROFESSIONAL EQUIPMENT OPERATORS

# OPERATING INSTRUCTIONS



908 W. Main • P.O. Box 368  
Laurel, MT USA 59044  
(1) 800-548-7341  
(1) 406-628-8231  
[www.wpg.com](http://www.wpg.com)

 **READ AND UNDERSTAND BEFORE  
OPERATING THIS EQUIPMENT**

APPLICABLE TO SERIAL NUMBERS 20240001  
AND LATER.



**MANUAL ROTATOR /  
POWER FILTER 700,  
AC-POWERED WITH  
INTELLI-GRIP®  
TECHNOLOGY**

Model number: MRPT411LAC3

Original Instructions © Wood's Powr-Grip Co., Inc.









# TABLE OF CONTENTS

<b>SPECIFICATIONS</b> .....	<b>3</b>
<b>SAFETY</b> .....	<b>5</b>
<b>OPERATING FEATURES</b> .....	<b>6</b>
INTELLI-GRIP® CONTROL UNIT FEATURES .....	7
<b>ASSEMBLY</b> .....	<b>8</b>
<b>INTENDED USE</b> .....	<b>10</b>
LOAD CHARACTERISTICS.....	10
INDIRECT LOADING .....	11
OPERATING ENVIRONMENT .....	11
DISPOSAL OF THE LIFTER .....	11
<b>OPERATION</b> .....	<b>12</b>
BEFORE USING THE LIFTER.....	12
Taking Safety Precautions .....	12
Selecting a Screen Language.....	12
Performing Inspections and Tests .....	13
TO USE THE PAD SHUTOFFS .....	14
TO ATTACH THE PADS TO A LOAD .....	15
Positioning the Lifter on the Load.....	15
Powering up the Lifter .....	15
Sealing the Pads on the Load .....	16
Reading the Vacuum Gauges .....	16
TO LIFT AND MOVE THE LOAD.....	17
Interpreting the Lift Light.....	17
Monitoring Vacuum Indicators .....	17
Controlling the Lifter and Load .....	18
In Case of a Power Failure.....	19
Using the Emergency Stop Button .....	19
TO ROTATE THE LOAD .....	20
TO TILT THE LOAD .....	21
TO RELEASE THE PADS FROM THE LOAD .....	22
AFTER USING THE LIFTER.....	23
Storing the Lifter .....	24

# TABLE OF CONTENTS

Transporting the Lifter .....	24
<b>INSPECTIONS AND TESTS.....</b>	<b>25</b>
INSPECTION SCHEDULE .....	25
TESTING .....	26
Lifter/Load Compatibility Test.....	26
Operational Tests .....	27
Vacuum Test.....	27
Rated Load Test.....	28
<b>MAINTENANCE .....</b>	<b>29</b>
VACUUM PAD MAINTENANCE.....	29
Pad-to-Load Friction Coefficient .....	29
Pad Inspection .....	29
Pad Cleaning .....	30
NOTIFICATION BUZZER BATTERY REPLACEMENT .....	31
INTELLI-GRIP® DIAGNOSTIC CODES .....	32
<b>REPLACEMENT PARTS.....</b>	<b>36</b>
<b>REGISTRATION AND LIMITED WARRANTY .....</b>	<b>37</b>
TO REGISTER THIS WPG PRODUCT .....	37
ABOUT THE LIMITED WARRANTY .....	37
Obtaining Warranty Service or Repair Service.....	37

# SPECIFICATIONS







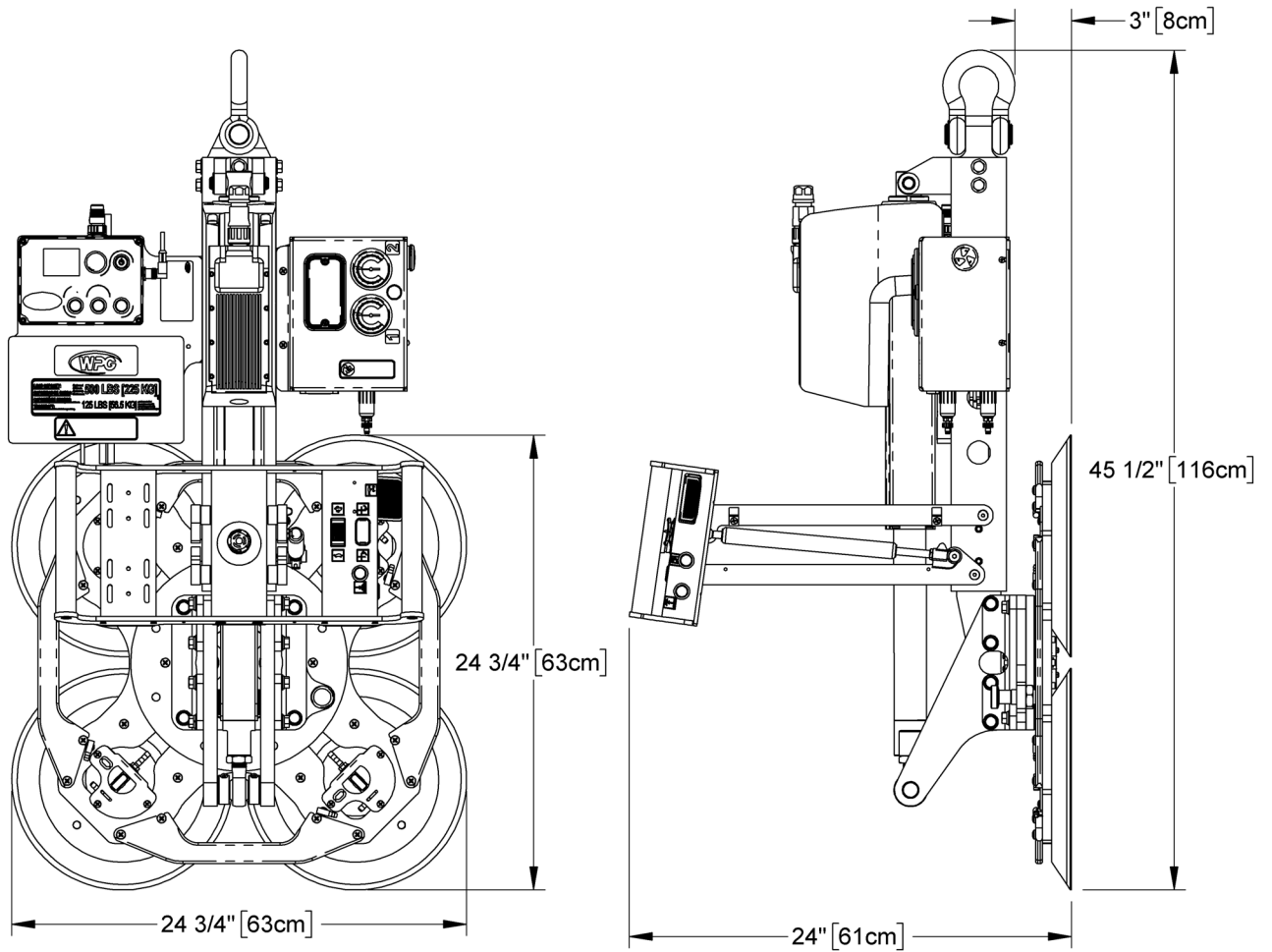













<b>Product Description</b>	Designed for use with hoisting equipment, MRPT4-AC3 lifters support loads using vacuum and manipulate loads using powered 90° tilt motions and manual 360° pad-frame rotation
<b>Model Number</b>	MRPT411LAC3
<b>Pad Spread</b> (to outer edges)	24¾" x 24¾" [63 cm x 63 cm]
 <b>Maximum Load Capacity</b> <sup>1</sup>	Per pad: 175 lbs [79.5 kg] Total: 700 lbs [320 kg]
 <b>Lifter Weight</b>	150 lbs [68 kg]
<b>Vacuum Pads</b> (standard rubber <sup>2</sup> )	11" [28 cm] nominal diameter, lipped (Model G3370)
<b>Power Source</b>	See serial number plate for specific AC voltage, frequency and amperage.
 <b>Rotation Capability</b>	Manual, 360° with 8 rotation stops (every 45°)
 <b>Tilt Capability</b>	Powered, 90°; continuous with adjustable speed controller
 <b>Operating Elevation</b>	Up to 6,000' [1,828 m]
 <b>Operating Temperatures</b>	32° — 104° F [0° — 40° C]
<b>Service Life</b>	20,000 lifting cycles, when used and maintained as intended <sup>3</sup>
<b>ASME Standard BTH-1</b>	Design Category "B", Service Class "0"
<b>Troubleshooting Guide</b>	<a href="#">TST-016_GENERIC_LEAK_TEST_rev_2014-086</a>

- 1..... The Maximum Load Capacity is rated at a vacuum of 16" Hg [-54 kPa] on clean, smooth, nonporous flat surfaces with a friction coefficient of 1. Pad compound, load rigidity, strength, surface conditions, overhang, angle, center of gravity and temperature can also affect the lifting capacity. A "qualified person" should evaluate the effective lifting capacity for each use (see definition under "Rated Load Test").
- 2..... Available with [other rubber compounds](#) for special purposes.
- 3..... Vacuum pads, filter elements and other wear-out items are excluded.

# SPECIFICATIONS



# SAFETY

-  Wear personal protective equipment that is appropriate for the load material. Follow trade association guidelines.
-  Do not remove or obscure safety labels.
-  Do not make any modifications to the lifter (see “LIMITED WARRANTY”).
-  Use the lifter only in an approved “OPERATING ENVIRONMENT” (see “INTENDED USE”).
-  Make sure to consider all possible effects of “INDIRECT LOADING” on lifting capacity (see “INTENDED USE”).
-  Do not use a lifter that is damaged, malfunctioning, or missing parts.
-  Do not use a lifter if the sealing edge of any vacuum pad is cut or otherwise damaged.
-  Do not use a lifter to lift cracked or broken glass.
-   Do not exceed the Maximum Load Capacity or lift loads the lifter is not designed for (see “INTENDED USE”).
-   Do not use a lifter if the Maximum Load Capacity or any safety label appears to be missing or obscured.
-  Make sure the contact surfaces of the load and vacuum pads are clean before attaching the lifter (see “MAINTENANCE”).
-  Position the vacuum pads correctly on the load before lifting (see “OPERATION”).
-  Do not lift a load if any vacuum indicator shows inadequate vacuum.
-  Keep unauthorized personnel away from the lifter, to avoid injury in case of an unintended load release.
-  Do not touch the vacuum release controls during a lift.
-  Do not allow people to ride on the lifter or the load.
-  Do not lift a load higher than necessary or leave suspended loads unattended.
-  Do not position a loaded or unloaded lifter over people.
-  Before servicing a powered lifter, place the power control in the inactive position and, when possible, disconnect the power source.

# OPERATING FEATURES

Features shown here are underlined> on their first appearance in each section following.

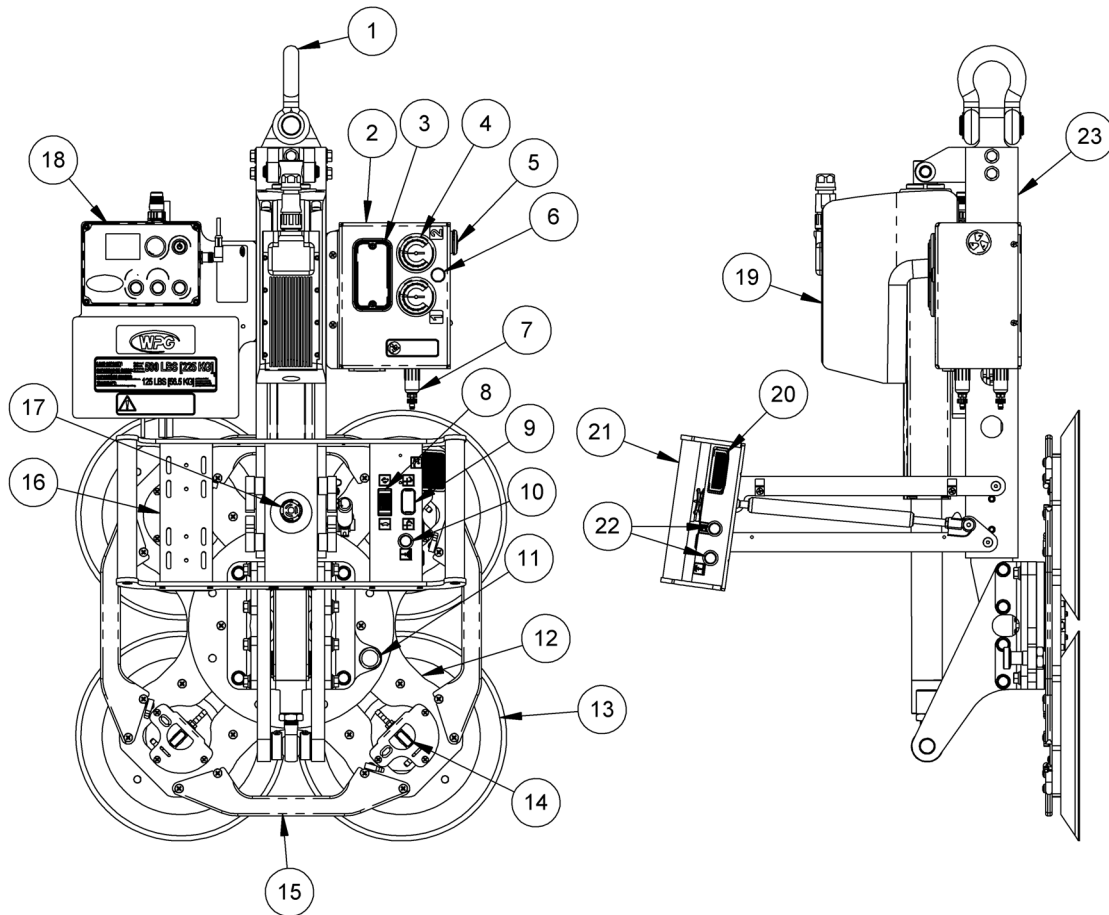

- |    |                                     |    |  |    |                              |
|----|-------------------------------------|----|--|----|------------------------------|
| 1  | LIFT POINT                          | 2  | Enclosure for VACUUM PUMP,<br>VACUUM SENSORS       | 3  | STROBE LIGHT                 |
| 4  | VACUUM GAUGE                        | 5  | NOTIFICATION BUZZER                                | 6  | VACUUM LIFT LIGHT            |
| 7  | AIR FILTER                          | 8  | TILT SPEED CONTROLLER                              | 9  | TILT TOGGLE SWITCH           |
| 10 | "ATTACH" BUTTON                     | 11 | ROTATION RELEASE PIN                               | 12 | PAD FRAME                    |
| 13 | VACUUM PAD                          | 14 | PAD SHUTOFF  | 15 | PAD FRAME CONTROL HANDLE     |
| 16 | PENDANT HOLDER                      | 17 | EMERGENCY STOP BUTTON                              | 18 | INTELLI-GRIP® CONTROL UNIT   |
| 19 | TILT ACTUATOR                       | 20 | RELEASE PADDLE for ARTICULATING<br>CONTROL HANDLES | 21 | ARTICULATING CONTROL HANDLES |
| 22 | "FUNCTION" and "RELEASE"<br>BUTTONS | 23 | LIFT BAR   |    |                              |
- Not Shown: AC-to-DC POWER CONVERTER

*Note: Although some of the following photos do not show this specific lifter, they all illustrate how this kind of lifter functions.*

For information about specific parts, see ["REPLACEMENT PARTS"](#) and/or any separate instructions for Product Options.



# OPERATING FEATURES

## INTELLI-GRIP<sup>®</sup> CONTROL UNIT FEATURES

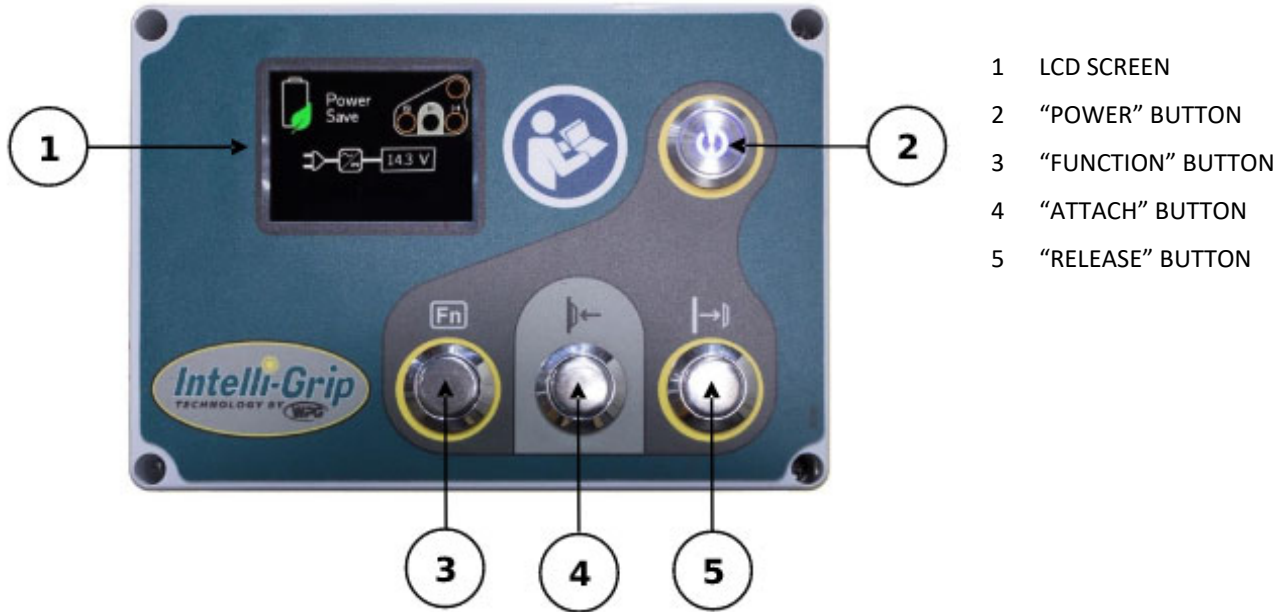

# ASSEMBLY

- 1) Remove all shipping materials and save them with the shipping container for future use.
- 2) Connect the power cable:



**Make sure power source has ground fault circuit interrupter.**

- 2.1) Wire the female connector provided to an appropriate power source, as indicated on the label attached.



**Wiring must be performed by qualified service personnel, taking all appropriate safety precautions.**

*Note: Brown-outs, over-taxed generators, extension cords and other conditions can reduce power at the lifter.*



**Without adequate power, lifter could release load, resulting in load damage and personal injury.**

- 2.2) Route the power cable so that it does not become damaged during operation.
- 2.3) Insert the power cable's male connector into the female connector and twist to secure them together (figs. 2A-B).

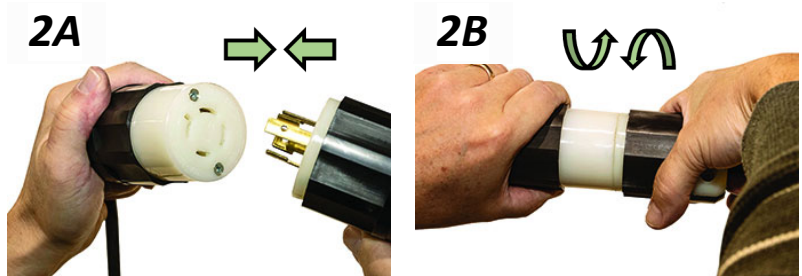

- 3) Suspend the lifter from appropriate hoisting equipment:

- 3.1) Select a crane and/or hoist rated for the Maximum Load Capacity plus the Lifter Weight.



*Note: Any lifter use must comply with all statutory or regulatory standards for hoisting equipment in your region.*

- 3.2) Engage the tilt actuator to raise the lift bar (figs. 3A-B; see ["TO TILT THE LOAD"](#)).

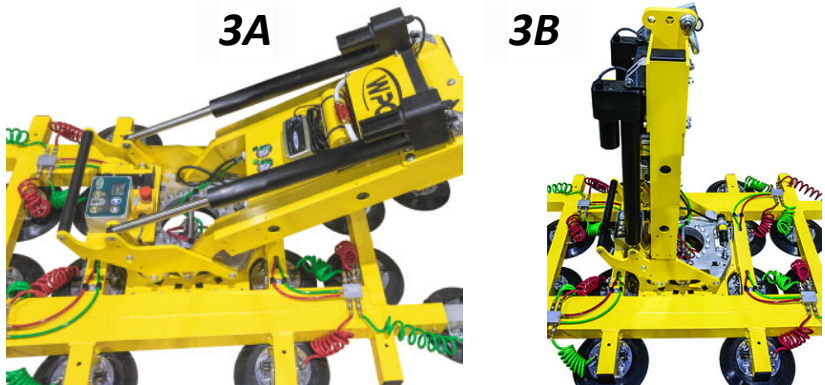

# ASSEMBLY

3.3) Attach the hoisting hook to the lift point (fig. 3C).

**!** *Make sure hook has restraining latch (see arrow in fig. 3D).*



*Note: Use rigging (fig. 3E) as needed to make sure the hook does not interfere with the load.*

**!** *Only use rigging rated for Maximum Load Capacity plus Lifter Weight.*

3.4) Use the hoisting equipment to remove the lifter from the shipping container. Avoid damaging the vacuum pads.

*Note: The hoist control pendant can be attached to the lifter by inserting it into the pendant holder (fig. 3F).*



4) Remove the pad covers (fig. 4A) and save them for future use.



5) Perform tests as required under **“TESTING”**.

# INTENDED USE

## LOAD CHARACTERISTICS

Make sure the vacuum lifter is intended to handle each load according to these requirements:



**Do NOT lift explosives, radioactive substances or other hazardous materials.**



- The load weight must not exceed the Maximum Load Capacity.
- The load must be a single piece of relatively nonporous material with a flat and relatively smooth contact surface.<sup>1, 2</sup> To determine whether the load is too porous or rough, perform the “[Lifter/Load Compatibility Test](#)”.
- The load's contact surface must be able to obtain a friction coefficient of 1 with the lifter's vacuum pads (see “[Pad-to-Load Friction Coefficient](#)”). Otherwise, the capacity should be derated appropriately.
- The load's surface temperature must not exceed the Operating Temperatures.<sup>3</sup>
- The load's *minimum* length and width are determined by the current Pad Spread (see “SPECIFICATIONS”).
- The load's *maximum* length and width are determined by its allowable overhang.<sup>4</sup>
- 1" [2.5 cm] is the allowable thickness at Maximum Load Capacity.<sup>5</sup>



*Note: Standard vacuum pads can stain or deform load surfaces with light colors or soft coatings. Test such surfaces for damaging effects before using the lifter on them.<sup>6</sup>*

1..... Although concave vacuum pads can also attach to some curved loads, curvature can reduce lifting capacity. Contact WPG for more information.

2..... A “single piece” of material includes curtainwall assemblies, unitized glazing systems and similar construction units.

3..... Vacuum pads made from a heat-resistant rubber compound can enable you to lift loads with higher surface temperatures. Contact WPG or an authorized dealer for more information.

4..... The allowable overhang is the amount of load material that can extend sideways beyond the vacuum pads without breaking or otherwise being damaged. This depends on the load material, its thickness, and the angle of handling (if any). Since every material has different physical properties, the allowable overhang must be evaluated separately for each load type. Contact WPG or an authorized dealer for more information.

5..... However, the allowable thickness increases as load weight decreases. Contact WPG for more information.

6..... Alternative rubber compounds are available for these purposes. Contact WPG or an authorized dealer for more information.

# INTENDED USE

## INDIRECT LOADING

Make sure to account for dynamic loading or other inadvertent loading that can negatively affect lifting capacity, such as:

- Weight amplification that results when a loaded vacuum lifter abruptly starts/stops moving, changes direction or bounces up and down (eg, when a telehandler transports a loaded lifter across rough terrain).
- External force that effectively increases the weight of a lifter's attached load (eg, when a load of sheet material reacts to wind gusts).



**Indirect loading can reduce lifting capacity.**

## OPERATING ENVIRONMENT

Make sure the lifter is suitable for each work environment, given the following restrictions:

- This lifter is not intended for any environment that is dangerous to the operator or damaging to the lifter. Avoid environments containing explosives, caustic chemicals and other dangerous substances.



**Never use lifter in dangerous environments.**



**Metal particles and similar environmental contaminants could result in vacuum pump failure.**

- The work environment is limited by the Operating Elevation and Operating Temperatures.<sup>1, 2</sup>
- The lifter is not designed to be watertight. Do not use it in rain or other unsuitable conditions.

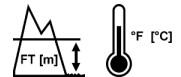

**Moisture can reduce lifting capacity.**

## DISPOSAL OF THE LIFTER

After the Service Life of the lifter has ended (see "SPECIFICATIONS"), dispose of it in compliance with all local codes and applicable regulatory standards.

1..... Although lifter use may be possible at higher elevation, lifting capacity is reduced whenever the lifter is unable to attain vacuum in the green range on the vacuum gauges. Contact WPG for more information.

2..... Special provisions may allow the lifter to operate outside the specified temperature range. Contact WPG for more information.

# OPERATION

## BEFORE USING THE LIFTER

Determine whether the vacuum lifter is capable of each intended task (see “SPECIFICATIONS” and “[INTENDED USE](#)”). Then complete the following preparations:

### Taking Safety Precautions

- Be trained in all industry and regulatory standards for lifter operation in your region.
- Follow trade association guidelines about precautions needed for each load material.



**Read all directions and safety rules before using lifter.**



**Always wear appropriate personal protective equipment.**

### Selecting a Screen Language

When the lifter is powered up for the first time, the [Intelli-Grip® control unit](#) prompts the operator to select a language for the [LCD screen](#). Use the buttons as follows:



- To scroll down, press the “[release](#)” button (|→|).
- To scroll up, press the “[attach](#)” button (|←|).
- To select a language, press the “[function](#)” button (Fn).<sup>1</sup>



*Note: A similar process is used to navigate all menus.*

<sup>1</sup>..... To change the language again, refer to the “INTELLI-GRIP® OPERATOR MENUS” section of the [SERVICE MANUAL](#).

## Performing Inspections and Tests

- Follow the “[INSPECTION SCHEDULE](#)” and “[TESTING](#)”.
- Service the 2 air filters whenever a bowl contains liquid or other contaminants, or an element appears dirty (see “AIR FILTER MAINTENANCE” in [SERVICE MANUAL](#)).

Make sure the notification buzzer is clearly audible at the maximum distance between the operator and the lifter, despite any barriers or obstacles.<sup>1, 2</sup>



***Examine air filters regularly and service when needed.***



***Make sure notification buzzer can be heard over noise at operator position.***

---

1..... Maximum buzzer volume is 95 dBA at 2' [60 cm]. If CE or UKCA Standards apply, consult EN 7731 to make sure the notification buzzer is compliant.

2..... The “[Vacuum Test](#)” provides a convenient opportunity to check this.

## TO USE THE PAD SHUTOFFS

Pad shutoffs on each of the pad mounts control the vacuum line to the vacuum pads. Activating or deactivating the airflow at these pads enables the lifter to handle loads with different weights and dimensions (see “SPECIFICATIONS”) or to avoid holes in the load surface.

To support the maximum load weight and larger load dimensions, all pads must be activated; for smaller weights and dimensions, some pads may be deactivated, **provided that the lifter still has sufficient capacity to support the load** (see “LOAD CHARACTERISTICS”).



**Closing any pad shutoff reduces lifting capacity.**

To activate a pad, open the shutoff valve (ie, place lever *parallel* with vacuum line — fig. 1A).



To deactivate a pad, close the shutoff valve (ie, place lever *perpendicular* to vacuum line — fig. 1B).



To calculate the lifting capacity when some pads are deactivated, consult the Per-Pad Load Capacity and multiply by the number of pads currently activated. Always activate pads in a symmetrical configuration and use as many pads as possible for each load being lifted, to maximize lifting capacity and to minimize load overhang.





# OPERATION

## To ATTACH THE PADS TO A LOAD

Make sure the contact surfaces of the load and vacuum pads are clean (fig. 1A; see “[Pad Cleaning](#)”).

1A



## Positioning the Lifter on the Load

- 1) Center the pad frame on the load (fig. 1B).<sup>1</sup>
- 2) Make sure vacuum pads will fit on the load and will be loaded evenly.

 Consult the Per-Pad Load Capacity.

- 3) Place the vacuum pads in contact with the load surface.

1B



## Powering up the Lifter

Press the power button on the Intelli-Grip® control unit (⏻ — fig. 1C). The vacuum pump will run for a few seconds, as a normal function of the Intelli-Grip® self-diagnostics.

The lifter automatically tests the 9-volt battery for the notification buzzer each time the lifter is powered up. When this battery runs down, the LCD screen displays “Replace 9V battery?” and the buzzer chirps once per minute. Replace the battery as needed (see “[NOTIFICATION BUZZER BATTERY REPLACEMENT](#)”).

1C



1..... The lifter is designed to handle the maximum load weight when the load’s center of gravity is positioned within 2" [5 cm] of the pad frame’s center point. Uncentered loads may rotate unexpectedly or interfere with the lifter’s tilt capability.

# OPERATION

## Sealing the Pads on the Load

Press the “attach” button (↩) on the articulating control handles (fig. 1A) or the Intelli-Grip® control unit (fig. 1B).



**! Keep “attach” function activated throughout lift.**

The vacuum pump will run until the vacuum pads seal completely. If the lifter takes too long to attach, the notification buzzer chirps and the LCD screen displays “Vacuum not increasing normally”, along with a diagnostic code (see “[INTELLI-GRIP® DIAGNOSTIC CODES](#)”). In this case, press the lifter firmly against the load to help the pads begin to seal.<sup>1</sup>

## Reading the Vacuum Gauges

The 2 vacuum gauges of the dual vacuum system show the current vacuum level in positive inches of Hg and negative kPa:

- **Green range** ( $\geq 16$ " Hg [ $\leq -54$  kPa]): Vacuum level is sufficient to lift the maximum load weight (fig. 1C).
- **Red range** ( $< 16$ " Hg [ $> -54$  kPa]): Vacuum level is **not** sufficient to lift the maximum load weight (fig. 1D).<sup>2</sup>



If it takes more than 5 seconds for the vacuum level to reach 5" Hg [-17 kPa] on either vacuum gauge, press on any vacuum pad that has not yet sealed. Once the pads have sealed, the lifter should be able to maintain sufficient vacuum for lifting, except when used above the maximum Operating Elevation.<sup>3</sup> If it does not, perform the “[Vacuum Test](#)”.

1..... Although a vacuum pad may become distorted during shipping or storage, this condition should correct itself with continued use.

2..... The gauge face colors do not correspond with the circuit colors.

3..... If the lifter is used above the maximum Operating Elevation (see “[SPECIFICATIONS](#)”), it may not be able to maintain sufficient vacuum for lifting. Contact WPG for more information.

# OPERATION

## TO LIFT AND MOVE THE LOAD

 ***Lift bar must be vertical to lift load.***

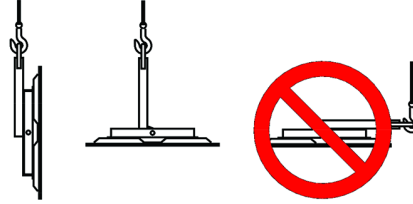

## Interpreting the Lift Light

 When vacuum is sufficient to lift the Maximum Load Capacity, the vacuum lift light turns *on* automatically and the vacuum pump turns *off* temporarily.

 ***Never lift load unless lift light is illuminated, because premature lifting could result in load release and personal injury.***

## Monitoring Vacuum Indicators

Monitor the vacuum lift light and both vacuum gauges throughout the entire lift (fig. 1A).

1A

 ***Make sure all vacuum indicators remain completely visible.***

The vacuum pump turns on and off to overcome any leakage. However, if the leak rate is greater than normal, the notification buzzer chirps and the LCD screen displays the message “Vacuum decrease on circuit #”, along with a diagnostic code (see “[INTELLI-GRIP® DIAGNOSTIC CODES](#)”).<sup>1</sup>



1..... Automatic leak detection is **not** a substitute for performing the “[Vacuum Test](#)”, required by the “[INSPECTION SCHEDULE](#)” and “[TESTING](#)”. Sensitivity of leak detection can be adjusted (see “[INTELLI-GRIP® OPERATOR MENUS](#)” in [SERVICE MANUAL](#)).

# OPERATION

If the vacuum pump is unable to overcome leakage, the notification buzzer sounds continuously, the lift light turns off, and the LCD screen displays the message “INSUFFICIENT VACUUM!”, along with a diagnostic code (see “INTELLI-GRIP® DIAGNOSTIC CODES”). If this happens:

- 1) Keep everyone away from a suspended load until it can be safely lowered to a stable support.



**Stay clear of any suspended load while indicators warn of insufficient vacuum.**

- 2) Stop using the lifter until the cause of the vacuum loss can be identified: Conduct the “Pad Inspection” and perform the “Vacuum Test”.
- 3) Correct any faults before resuming normal operation of the lifter.

## Controlling the Lifter and Load



**Never allow any pad shutoff to be opened or closed while lifting, because this could result in a load release and personal injury.**

When the lifter is ready, use the hoisting equipment to raise the lifter and load as needed.

Use the articulating control handles (fig. 1A and inset) to keep the lifter and load in the required position.

*Note: Depress the release paddle (circled in inset) to move the handles to the desired vertical position.*

Once there is enough clearance, move the load as required.

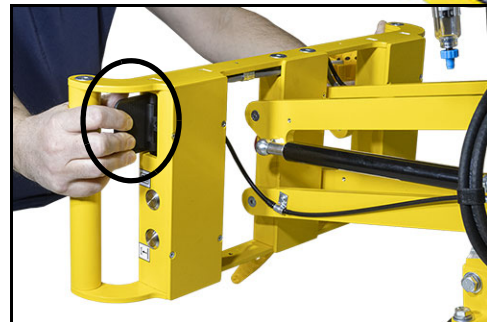
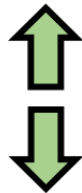

# OPERATION

## In Case of a Power Failure

Although the lifter is designed to support the load for at least 5 minutes without power, this depends on many factors, including the “LOAD CHARACTERISTICS” and the condition of the vacuum pads (see “VACUUM PAD MAINTENANCE”).

If a power failure occurs, keep everyone away from a suspended load until it can be safely lowered to a stable support. Correct any faults before resuming normal operation of the lifter.

 **Stay clear of any suspended load during power failure.**

## Using the Emergency Stop Button

If necessary, press the emergency stop button (fig. 1A) to immediately stop tilt motion.

**Caution:** Pressing the stop button will **not** stop rotation motions.

**Note:** Pressing the stop button will **not** stop the vacuum generating system from functioning.

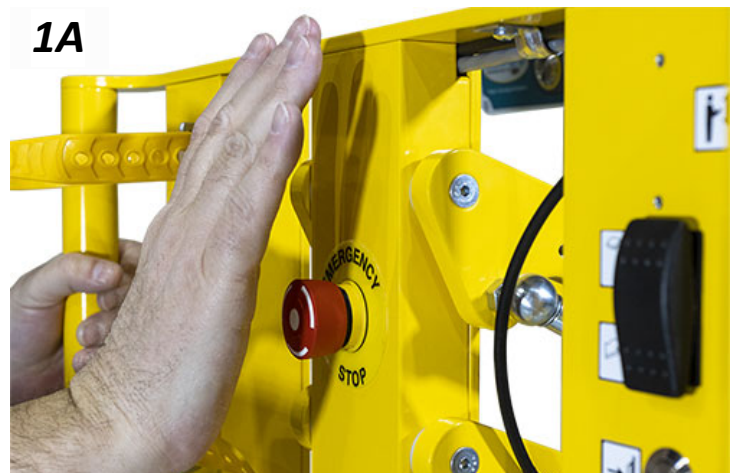

Once the stop button is pressed, any attempt to use the tilt toggle switch will be prevented.

To reset the stop button, twist the button clockwise and allow it to spring outward to its original position.

# OPERATION

## To ROTATE THE LOAD

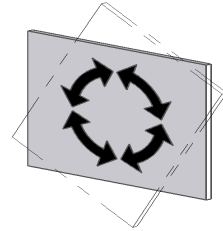

**Make sure load is positioned correctly on lifter, as previously directed.**

1) Make sure the load has enough clearance to rotate without contacting anyone or anything.



**Keep hands and fingers away from pinch points between pad frame and lift bar.**

2) Use the pad frame control handle to keep the load under control at all times.



**Unbalanced loads may rotate unexpectedly when rotation latch is disengaged.**

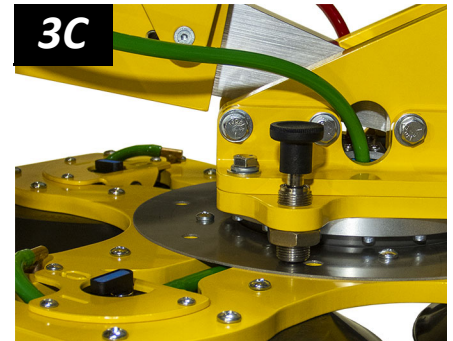
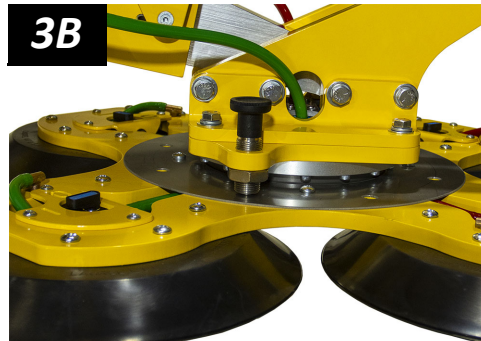

3) Pull the rotation release pin knob (fig. 3A) to disengage the rotation pin. This allows the load to be rotated until the next rotation stop, where the pin will automatically engage again (fig. 3B).

*Note: As you pull the pin, you can twist the knob 180° until the pin locks (fig. 3C). This will prevent the pin from automatically engaging at the next stop.*

4) Rotate the load to the desired rotation stop (figs. 4A-B). If necessary, twist the pin knob to engage the pin.

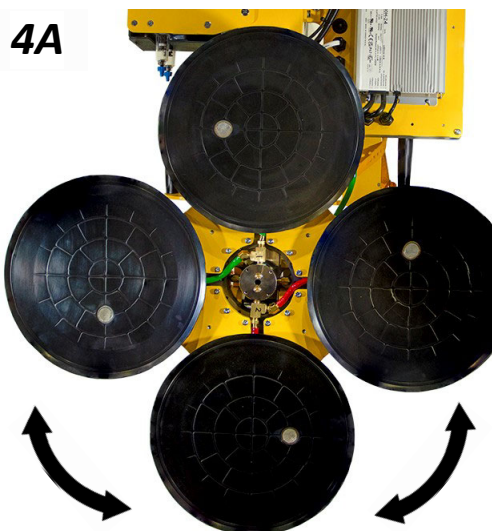

*Note: Whenever rotation is not required, keep the pin engaged, to prevent load damage or personal injury.*

# OPERATION

## To TILT THE LOAD



**Make sure load is positioned correctly on lifter, as previously directed.**

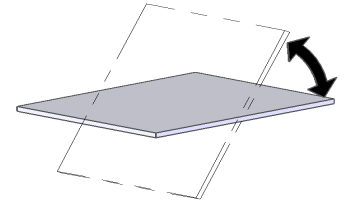

- 1) Make sure the load has enough clearance to tilt without contacting anyone or anything.
- 2) Press the tilt toggle switch, to engage the tilt actuator, and tilt the load as desired:

- Press the top part of the switch, to tilt the load toward the flat position (fig. 2A).
- Press the bottom part of the switch, to tilt the load toward the upright position (fig. 2B).



*Note: As desired, move the tilt speed controller (circled in fig. 2A) upward to make the load tilt faster or downward to make the load tilt more slowly.*

- 3) Continue pressing the tilt toggle switch until you reach the desired tilt angle (fig. 3A and inset). Then release the switch, to stop motion.

*Note: See “LOAD CHARACTERISTICS” about allowable load overhang.*



# OPERATION

## TO RELEASE THE PADS FROM THE LOAD

**!** *Make sure load is at rest and fully supported before releasing vacuum pads.*

- 1) Press and hold the “function” button (Fn) and the “release” button (Release) on the articulating control handles (fig. 1A) at the same time, to break the vacuum seal.



Alternatively, press the corresponding buttons on the Intelli-Grip® control unit (fig. 1B).



If the seal does not break, follow the directions on the LCD screen.

*Note: The strobe light (fig. 1C) flashes while the “function” or “release” button is held, to show the operator that signals are being transmitted and to warn others that the operator may be releasing the load.*

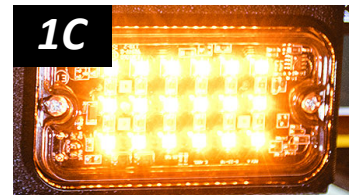

- 2) Continue to hold the “function” and “release” buttons until the vacuum pads release the load completely. Otherwise, the vacuum lifter will automatically revert to “attach” mode.<sup>1</sup>

**⊘** *Do not move lifter until pads release completely, because such movement could result in load damage or personal injury.*

After the load is successfully released, the lifter activates the “Power Save” mode automatically.

- 3) Before you lift another load, perform the Every-Lift Inspection (see “[INSPECTION SCHEDULE](#)”).

1..... A “Timed Release” function can be used to help separate the lifter from the load: Hold the “function” and “release” buttons until a yellow arrow appears on the LCD screen. Then tap the “function” button 2 or more times. This prolongs the release mode for 5 seconds per each additional tap.



# OPERATION

## AFTER USING THE LIFTER

- 1) Make sure the pad frame is in flat position (fig. 1A).



- 2) Move the articulating control handles to their uppermost position (fig. 2A), to keep the lifter balanced after it is set down.

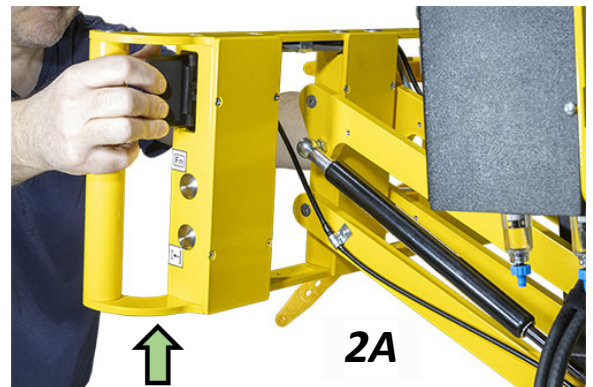

- 3) Use the hoisting equipment to lower the vacuum lifter gently onto a stable support. Then detach the hoisting hook from the lift point.

**Caution:** Do not set the lifter on surfaces that could soil or damage vacuum pads.

- 4) Press the power button (⏻) — fig. 4A) and the “function” button (Fn) — fig. 4A) to power down the vacuum lifter.



# OPERATION

## Storing the Lifter

- 1) Disconnect the electrical connectors (figs. 1A-B).

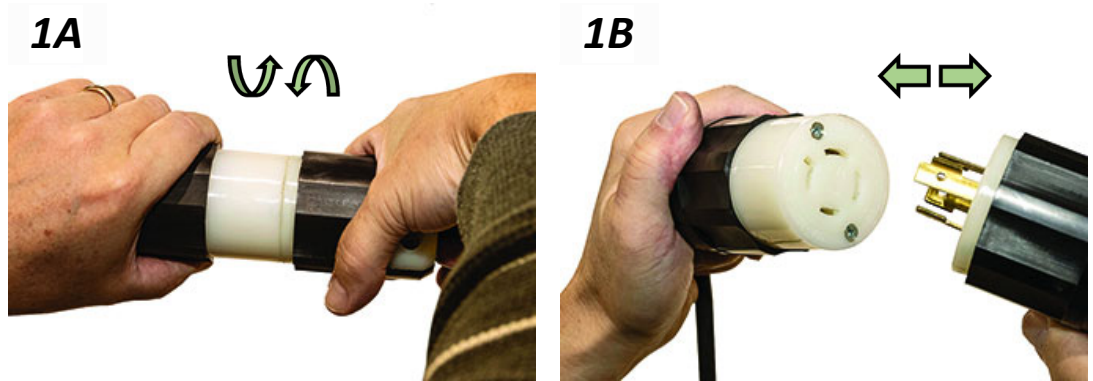

- 2) Use the covers supplied to keep the vacuum pads clean (fig. 2B).

**CE/UKCA** — *To prevent the lifter from tipping over on relatively horizontal surfaces, place the vacuum pads facedown on a clean, smooth, flat surface. Then lower the lift bar and place a support under the lift point.*



- 3) Store the lifter in a clean, dry location.

## Transporting the Lifter

Secure the lifter in the original shipping container with the original shipping materials or equivalent:

- 1) ***Before lowering the lifter into the container***, make sure the pad frame is in the flat position and the articulating control handles are moved to their lowest position.
- 2) Use hoisting equipment to lower the lifter into the container.

Lower the lift bar, making sure it is supported during transport, to prevent damage to the tilt actuator.

# INSPECTIONS AND TESTS

## INSPECTION SCHEDULE

Perform inspections according to the following frequency schedule. If any fault is found, correct it and perform the next most frequent inspection before using the vacuum lifter.

*Note: If a lifter is used less than 1 day in a 2-week period, perform the Periodic Inspection before using it.*

Action	Every Lift	Frequent <sup>1</sup> <small>(Every 20-40 hrs.)</small>	Periodic <sup>2</sup> <small>(Every 250-400 hrs.)</small>
Examine <u>vacuum pads</u> for contaminants or damage (see “ <a href="#">Pad Inspection</a> ”).	✓	✓	✓
Examine load surface for contaminants or debris.	✓	✓	✓
Examine controls and indicators for damage.	✓	✓	✓
Examine lifter’s structure for damage.		✓	✓
Examine vacuum system for damage (including <u>vacuum pads</u> , fittings and hoses).		✓	✓
Examine <u>air filters</u> for conditions requiring service (see “AIR FILTER MAINTENANCE” in <a href="#">SERVICE MANUAL</a> ).		✓	✓
Perform “ <a href="#">Vacuum Test</a> ”.		✓	✓
Check for unusual vibrations or noises while operating lifter.		✓	✓
Examine entire lifter for evidence of: <ul style="list-style-type: none"> <li>• looseness, excessive wear or excessive corrosion</li> <li>• deformation, cracks, dents to structural or functional components</li> <li>• cuts in vacuum pads or hoses</li> <li>• any other hazardous conditions</li> </ul>			✓
Inspect entire electrical system for damage, wear or contamination that could be hazardous, in compliance with all local codes and regulatory standards. <b>Caution:</b> Use appropriate cleaning methods for each electrical part, as specified by codes and standards. Improper cleaning can damage parts.			✓

1..... The Frequent Inspection is also required whenever the lifter has been out of service for 1 month or more.

2..... The Periodic Inspection is also required whenever the lifter has been out of service for 1 year or more. Keep a written record of all Periodic Inspections. If necessary, return the lifter to WPG or an authorized dealer for repair (see “[REGISTRATION AND LIMITED WARRANTY](#)”).

## TESTING

Perform the following test to determine whether or not a load surface is too porous or rough:

### Lifter/Load Compatibility Test<sup>1</sup>

- 1) Make sure the vacuum generating system is functioning correctly (see “[Vacuum Test](#)”).
- 2) Thoroughly clean the load surface and the vacuum pads (see “[Pad Cleaning](#)”).<sup>2</sup>
- 3) Place the load in the upright position on a stable support.
- 4) Attach the vacuum pads to the load as previously directed.
- 5) After the vacuum pump stops running, hold the “function” button (Fn) and the “power” button (⏻) for at least 5 seconds to power down the vacuum lifter.

*Note: During this time the LCD screen displays “WARNING! Is load attached?”, the notification buzzer chirps rapidly and the strobe light flashes.*

- 6) Raise the load a minimal distance, to make sure it is supported by the lifter.
- 7) Watch each vacuum gauge: **Starting from a vacuum level of 16" Hg [-54 kPa], the lifter must maintain a vacuum level greater than 12" Hg [less than -41 kPa] for 5 minutes.**<sup>3</sup> If not, lifting this load requires additional precautions (eg, a load sling). Contact WPG for more information.
- 8) Lower the load *after* 5 minutes or *before* the vacuum level diminishes to 12" Hg [increases to -41 kPa].



**Take precautions in case load should fall during test.**

1..... The “[Pad-to-Load Friction Coefficient](#)” can affect the outcome of this test.

2..... Contaminated loads can also cause the vacuum pump to run frequently or continuously. Since excessive pumping quickly reduces battery energy, clean the load whenever possible.

3..... Under CE and UKCA requirements, the lifter must maintain a vacuum level **greater than 8" Hg [less than -27 kPa]**.

# INSPECTIONS AND TESTS

Perform the following tests before placing the lifter in service *initially* and *following any repair*, when directed in the “*INSPECTION SCHEDULE*”, or *whenever necessary*:

## Operational Tests

Test all features and functions of the lifter (see “OPERATING FEATURES” and “OPERATION”).

## Vacuum Test

- 1) Clean the face of each vacuum pad (see “Pad Cleaning”).
- 2) Use a test load with weight equal to the Maximum Load Capacity, a clean, smooth, nonporous surface and other appropriate “LOAD CHARACTERISTICS”.<sup>1</sup> 
- 3) Attach the lifter to the test load as previously directed. After the vacuum pump stops running, the vacuum level should appear in the green range on each of the vacuum gauges.
- 4) Raise the load a minimal distance. Then hold the “function” button (Fn) and the “power” button (⏻) for at least 5 seconds to power down the lifter.<sup>2</sup>

 **Take precautions in case load should fall during test.**
- 5) Watch the vacuum gauges: *The vacuum level should not decrease by more than 4" Hg [-14 kPa] in 5 minutes.*
- 6) Lower the load after 5 minutes or whenever a lifter fails the test, and release the load as previously directed. 

 **Never use lifter that has failed test.**
- 7) Qualified service personnel must correct any fault in the vacuum system before the lifter can be returned to service. 

 **This service must be performed by qualified service personnel.**

1..... The load should have either a flat surface or no more curvature than the lifter is designed for, if any.

2..... During this time, the LCD screen displays “WARNING: Is load attached?”, the notification buzzer chirps and the strobe light flashes.

# INSPECTIONS AND TESTS

## Rated Load Test<sup>1</sup>

The following steps must be performed or supervised by a qualified person:<sup>2</sup>

- 1) Use a test load that weighs 125% ( $\pm 5\%$ ) of the Maximum Load Capacity and has the appropriate “LOAD CHARACTERISTICS”. 
- 2) Attach the vacuum pads to the load as previously directed.
- 3) Position the load to produce the greatest stress on the lifter consistent with “INTENDED USE”.
- 4) Raise the load a minimal distance and leave it suspended for 2 minutes. 

 **Take precautions in case load should fall during test.**
- 5) Once the test is completed, lower and release the load as previously directed.
- 6) Inspect the lifter for any stress damage, and repair or replace components as necessary to successfully pass the test. 

 **Never use lifter that has failed test.**
- 7) Prepare a written report of the test and keep it on file.

---

1..... An equivalent simulation may also be used. Contact WPG for more information.

2..... A “qualified person” has successfully demonstrated the ability to solve problems relating to the subject matter and work, either by possessing a recognized degree in an applicable field or a certificate of professional standing, or by possessing extensive knowledge, training and experience.

# MAINTENANCE

Note: Refer to **SERVICE MANUAL #36106** when applicable.

## VACUUM PAD MAINTENANCE

### Pad-to-Load Friction Coefficient

The friction coefficient represents the lifter's ability to resist load slippage. The Maximum Load Capacity is based on a friction coefficient of 1, as determined by testing of clean, new, standard rubber vacuum pads on clean, dry, regular glass. **If the lifter is used under any other conditions, a qualified person must first determine the effective lifting capacity.**<sup>1</sup>



Long-term exposure to heat, chemicals or UV light can damage vacuum pads. Replace pads every 2 years or more often when necessary.

### Pad Inspection

Inspect each vacuum pad (fig. 1A) according to the “**INSPECTION SCHEDULE**” and correct the following faults before using the lifter (see “**REPLACEMENT PARTS**”, when applicable):

- Contaminants on the face (item 1 in fig. 1A) or sealing edges (item 2 in fig. 1A).
- Filter screen (item 3 in fig. 1A) missing from face.



**Replace any pad that has damaged sealing edges.**

- Nicks, cuts, deformation or abrasions in sealing edges.
- Wear, stiffness or glaze.

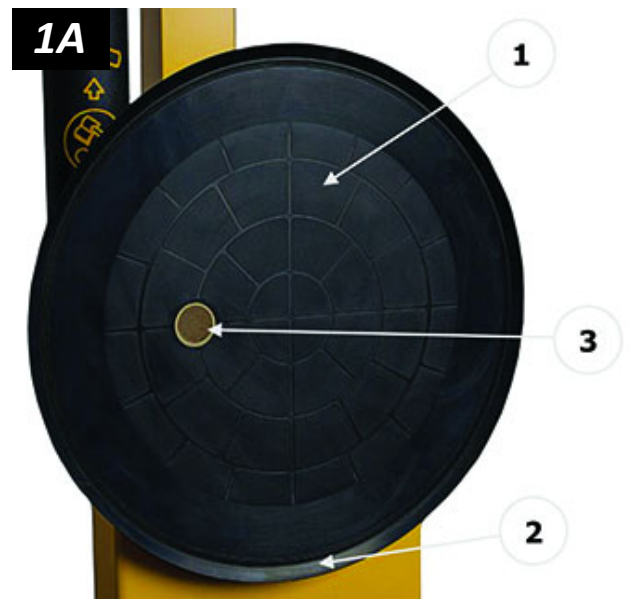

1..... A “qualified person” has successfully demonstrated the ability to solve problems relating to the subject matter and work, either by possessing a recognized degree in an applicable field or a certificate of professional standing, or by possessing extensive knowledge, training and experience.

## Pad Cleaning

- 1) Regularly clean the face of each vacuum pad (fig. 1A), using soapy water or other mild cleansers to remove oil, dust and other contaminants.



***Never use harsh chemicals on vacuum pad.***

Solvents, petroleum-based products (including kerosene, gasoline and diesel fuel) or other harsh chemicals can damage vacuum pads.



***Never use rubber conditioners on vacuum pad.***

Many rubber conditioners can leave a hazardous film on vacuum pads.

- 2) Prevent liquid from entering the vacuum system through the suction hole on the pad face.
- 3) Wipe each pad face clean, using a clean sponge or lint-free cloth to apply the cleanser.<sup>1</sup>
- 4) Allow each pad to dry completely before using the lifter.

1A



1..... A brush with bristles *that do not harm rubber* can help remove contaminants clinging to sealing edges. If these cleaning methods are not successful, contact WPG or an authorized dealer for assistance.



# MAINTENANCE

## NOTIFICATION BUZZER BATTERY REPLACEMENT

- 1) Power down the lifter.
- 2) Release the buzzer battery holder by pressing inward and sideward in the direction marked on the holder.
- 3) Slide the battery tray out (fig. 3A).
- 4) Install a new 9-volt battery according to the polarity markings.
- 5) Slide the battery tray back into position.
- 6) Power up the lifter again, to test the new battery.



# ← MAINTENANCE →

## INTELLI-GRIP® DIAGNOSTIC CODES

Refer to the following table when a diagnostic code appears on the LCD screen. Codes are listed in alphanumeric order. If the Explanations/Directions do not resolve the issue, contact qualified service personnel. All relevant parts are listed in “REPLACEMENT PARTS”.

*Note: This table contains many codes relevant to DC-powered lifters. If such codes display on AC-powered lifters, contact WPG for more information.*

Key:  = buzzer sounds     = buzzer sounds continuously     = strobe light flashes

Code	On-Screen Message	Buzzer Pattern	Strobe Light Activity	Explanations/Directions
B00	“Low 12V Battery (#)”	1 chirp every 2 seconds	(none)	Charge 12V <u>battery</u> or, if necessary, replace it. Cold battery may need to be warmed and/or charged more often.
B01	“Lockout (low 12V battery) (#)”	continuous	(none)	Once “Power Save” mode is activated, “attach” and “release” functions are prevented because 12V <u>battery</u> energy is insufficient. Charge battery before next lift.
B02	“Replace 12V battery?”	1 chirp per minute	(none)	Check condition of 12V <u>battery</u> . Since cold battery may prematurely activate this notification, warm battery and retest when appropriate. Replace battery as needed. Note: This notification can be activated in error if <u>battery</u> charger is plugged into power source while lifter is <u>powered</u> up. If so, power down lifter, disconnect charger from power source, and power up again. If code persists, check battery condition as directed above.
B03	“Charge 12V battery soon”	1 chirp per minute	(none)	Charge 12-volt <u>battery</u> .
B09	“Replace 9V battery?”	1 chirp per minute	(none)	Replace 9V battery for <u>notification buzzer</u> as needed (see “NOTIFICATION BUZZER BATTERY REPLACEMENT”).
C00	“Fail-safe on module”	continuous	on	Fail-safe mode has been activated, to prevent potential injury. Service is required.
C011	“Communication failure, module 1”	fast chirp	(none)	If code does not clear automatically, service is required.
C021	“Internal error, module 1”	continuous	(none)	If code does not clear automatically, service is required.
C04	“Module revision not compatible”	1 chirp every 2 seconds	(none)	Make sure lifter is used within Operating Temperatures (see “SPECIFICATIONS”). Then power lifter down and up again. If code persists, service is required.

# MAINTENANCE

Code	On-Screen Message	Buzzer Pattern	Strobe Light Activity	Explanations/Directions
C05	"Module revision lockout"	continuous (while button is held)	(none)	Once "Power Save" mode is activated, "attach" and "release" functions are prevented in connection with Code C04. Service is required.
C06	"Control head revision not compatible"	1 chirp every 2 seconds	(none)	Incompatible version of software was installed or <u>Intelli-Grip® control unit</u> has failed. Service is required.
C07	"Control head revision lockout"	continuous (while button is held)	(none)	Once "Power Save" mode is activated, "attach" and "release" functions are prevented in connection with Code C06. Service is required.
E00 E01 E02 E03 E04	"EEPROM error, cell #"	occasional chirp	(none)	Memory error detected. Service is required.
I000	"I2C error (#)"	single chirp	(none)	If code does not clear automatically , service is required.
N00	"Automatic attach"	(none)	(none)	System activated "attach" mode as precaution because significant vacuum was detected, even though no one initiated "attach" function. No corrective action is necessary. However, when appropriate, qualified service personnel can adjust sensitivity to vacuum detection.
N01	"Automatic attach"	(none)	(none)	System activated "attach" mode as precaution because load did not release completely. No corrective action is necessary. However, when appropriate, qualified service personnel can adjust sensitivity to vacuum detection.
N02	"Automatic attach"	(none)	(none)	System activated "attach" mode as precaution when lifter was powered up because power was previously lost while load was attached. No corrective action is necessary.
N03	"Unable to turn module power off"	1 chirp every 2 seconds	(none)	Remove 9V battery. Disconnect connector between 12V <u>battery</u> and vacuum generating system. Charge battery completely. Then reconnect battery and try to power down again. If code persists, disconnect connector. Service is required.
N04	"Failed to turn controls power off"	1 chirp every 2 seconds	(none)	Remove 9V battery. Disconnect connector between 12V <u>battery</u> and vacuum generating system. Charge battery completely. Then reconnect battery and try to power down again. If code persists, disconnect connector. Service is required.
N05	"Unable to turn module power on"	1 chirp every 2 seconds	(none)	Charge 12V <u>battery</u> . Then power lifter up again. If code persists, service is required.
N06	"Power-down reminder"	2 chirps	on briefly	Power down to prevent 12V <u>battery</u> discharge when lifter is not in use.
N07	"Auto power-down disabled"	(none)	(none)	Automatic power-down is prevented. Power lifter down and up again. If code persists, service is required.
N08	"powering down in # seconds"	1 chirp per minute	(none)	Lifter will automatically power down in number of seconds shown. Press any button to cancel action.

# ← MAINTENANCE →

Code	On-Screen Message	Buzzer Pattern	Strobe Light Activity	Explanations/Directions
N10	"App-support hardware fault"	(none)	(none)	Fault is detected in hardware that enables communication with mobile app. Power lifter down and up again. If code persists, service is required.
U00	"WARNING! Is load attached?"	fast chirp	on	Attempt was made to power down lifter while load was still detected. Lower load onto stable support and release load <i>before</i> powering down lifter.
U01	"Also hold [Fn] to power down"	(none)	(none)	Hold " <u>function</u> " button and " <u>power</u> " button at same time to power down lifter.
U02	"Turn off? Let go of buttons"	(none)	(possible)	Use only " <u>function</u> " button and " <u>power</u> " button to power down lifter. Lifter cannot be powered down while any other button is pressed.
U03	"Timed release: # seconds"	1 chirp per button press	on	Timed release function is activated for number of seconds shown (see " <a href="#">TO RELEASE THE PADS FROM THE LOAD</a> "). Press " <u>function</u> " button to cancel action or press " <u>attach</u> " button to override. No corrective action is necessary.
U04	"Also hold [Fn] to release"	(none)	(none)	Hold " <u>function</u> " button and " <u>release</u> " button at same time to release load.
U06	"Let go of [Fn] and Release"	(none)	on	Use only " <u>attach</u> " button to attach load. While " <u>attach</u> " button is pressed, lifter does not respond to pressing any other button. Release all buttons and press button(s) again to activate different function.
U08	"Menu not available in Attach"	(none)	(none)	Operator Menus cannot be accessed while lifter is attached to load.
U09	"Counterweight not retracted"	continuous	on	"Release" function is prevented because counterweight is not positioned correctly. Reposition counterweight as directed (see Counter-Balancer <i>OPERATING INSTRUCTIONS</i> , if necessary).
U10	"Use POWER button for Live Stats"	(none)	(none)	"Power" button (not " <u>function</u> " button) is now used to access Live Stats. No corrective action is necessary.
U11	"Testing battery - wait to attach"	(none)	(none)	"Attach" function is prevented because <u>battery</u> test is in progress. Wait until <u>vacuum pump</u> stops running and try again.
V000	"INSUFFICIENT VACUUM!"	continuous	on	Immediately lower load onto stable support until adequate vacuum can be obtained. Check load and <u>vacuum pads</u> for damage. Consult relevant topics in "ASSEMBLY", "OPERATION", "INSPECTIONS AND TESTS", and "MAINTENANCE".
V001 V002 V003 V004	"INSUFFICIENT VACUUM #!" (# indicates relevant vacuum circuit)	continuous	on	Immediately lower load onto stable support until adequate vacuum can be obtained in vacuum circuit indicated. Check load and <u>vacuum pads</u> for damage. Consult relevant topics in "ASSEMBLY", "OPERATION", "INSPECTIONS AND TESTS", and "MAINTENANCE". This code can be activated in connection with Code N00.

# MAINTENANCE

Code	On-Screen Message	Buzzer Pattern	Strobe Light Activity	Explanations/Directions
V011 V012 V013 V014 V015	"Vacuum decrease on circuit #"  (# indicates relevant vacuum circuit)	3 chirps	(none)	Vacuum decreased at greater rate than expected in circuit(s) indicated. Possible causes include bouncing or landing load, as well as use on rough or porous loads and other sources of vacuum leaks. Consult relevant topics in "ASSEMBLY", "OPERATION", "INSPECTIONS AND TESTS", and "MAINTENANCE" to eliminate leaks when possible. When appropriate, qualified service personnel can adjust sensitivity to vacuum level reductions.
V020	"Vacuum not increasing normally"	1 chirp every 2 seconds	on	Although lifter began to attach, vacuum level did not increase at normal rate. Make sure all <u>vacuum pads</u> seal securely (see " <a href="#">Sealing the Pads on the Load</a> " and " <a href="#">Reading the Vacuum Gauges</a> "). This Code can be activated by use at high elevation. If so, contact WPG for directions.
V03A V03B	"Pump running excessively"	1 chirp every 2 seconds	(none)	<u>Vacuum pump</u> is running more often than normal. Likely causes include significant vacuum leak or difficulty achieving minimum vacuum level due to high elevation. In case of suspected leak, check for fault(s) in vacuum system. See relevant topics in "ASSEMBLY," "OPERATION" "INSPECTIONS AND TESTS", and "MAINTENANCE". In case of high elevation, contact WPG for directions.
V040	"Lockout (vacuum sensor error)"	continuous	(none)	Once "Power Save" mode is activated, "attach" and "release" functions are prevented due to a <u>vacuum sensor</u> malfunction. Make sure sensor connectors are attached correctly.
V050	"DANGER! INSUFFICIENT VACUUM!"	continuous	on	Vacuum levels in BOTH circuits are insufficient for lifting. <b><i>Keep everyone away from suspended load until it can be safely lowered to a stable support.</i></b> Service is required.
V081 V082 V083 V084	"Sensor # error (low)"  (# indicates relevant vacuum circuit)	continuous in "attach" mode; 1 chirp every minute in "power save" mode	(none)	<u>Vacuum sensor</u> malfunction in vacuum circuit indicated. Make sure sensor connector is attached correctly.
V091 V092 V093 V094	"Sensor # error (high)"  (# indicates relevant vacuum circuit)	continuous in "attach" mode; 1 chirp every minute in "power save" mode	(none)	<u>Vacuum sensor</u> malfunction in vacuum circuit indicated. Make sure sensor connector is attached correctly.

# REPLACEMENT PARTS

Stock No.	Description	Qty.
Call WPG	Pad Shutoff Valve	4
53122	Pad Fitting – Elbow – 5/32" ID	4
49506TA	Vacuum Pad – Model G3370 / 11" [23 cm] Diameter, Lipped	4
36106	Service Manual – Dual Vacuum System – Intelli-Grip®	1
29353	Pad Cover	4
15630	Pad Filter Screen – Large	4

See **SERVICE MANUAL #36106** for additional parts.

**SERVICE ONLY WITH IDENTICAL REPLACEMENT PARTS,  
AVAILABLE AT [WPG.COM](http://WPG.COM) OR THROUGH AN AUTHORIZED WPG DEALER**

# REGISTRATION AND LIMITED WARRANTY

## TO REGISTER THIS WPG PRODUCT

Go to the [PRODUCT REGISTRATION](#) page at [wpg.com](#) and complete the form. Registration keeps you advised of important updates and notifications, and simplifies inquiries to WPG regarding your product. Registration is **not** required to activate your Limited Warranty (see next section).

## ABOUT THE LIMITED WARRANTY



*Note: Read the [WARRANTY RETURN FORM](#) at [wpg.com](#) for important details about the Limited Warranty.*

Wood's Powr-Grip® (WPG) products are warranted to be free from defects in manufacturing and materials for 1 year from the date of purchase.

If a problem develops during the warranty period, follow the instructions below to obtain warranty service. If inspection shows that the product has a defect, WPG will repair or replace the product without charge.



## Obtaining Warranty Service or Repair Service

**For customers in the U.S. and Canada:** Go to the [EXCHANGES, REPAIRS, & WARRANTIES](#) page at [wpg.com](#) and click the applicable link. Alternatively, you may contact the WPG Technical Service Department (see contact information below).

**For customers in all other localities:** Contact the WPG Technical Service Department (see contact information below) or your dealer for assistance.

ADDRESS	EMAIL	PHONE
Wood's Powr-Grip Co., Inc. 908 West Main St. Laurel, MT USA 59044	<a href="mailto:contactus@wpg.com">contactus@wpg.com</a>	(1) 800-548-7341 (1) 406-628-8231

KEEP FOR FUTURE REFERENCE

# ENGINEERING DRAWINGS

 INTENDED FOR USE BY SKILLED TECHNICAL  
PROFESSIONALS • READ AND UNDERSTAND  
BEFORE ROUTING, WIRING AND/OR ASSEMBLING

MANUAL ROTATOR /  
POWER FILTER 700,  
AC-POWERED WITH  
INTELLI-GRIP®  
TECHNOLOGY

Model number: MRPT411LAC3



908 W. Main • P.O. Box 368  
Laurel, MT USA 59044  
(1) 800-548-7341  
(1) 406-628-8231  
[www.wpg.com](http://www.wpg.com)



FILE DIRECTORY:  
FILE [SHEET]:

TYPE:  
**STANDARD**

712A-W01 [A-W02]

THIS DRAWING IS THE PROPERTY OF **WOOD'S POWR-GRIP CO., INC.**  
IT IS LOANED WITH THE UNDERSTANDING THAT NEITHER IT NOR ANY  
INFORMATION CONTAINED THEREIN WILL BE COPIED, PUBLISHED OR  
TRANSMITTED TO OTHERS WITHOUT EXPRESS WRITTEN PERMISSION.  
**WOOD'S POWR-GRIP CO., INC.**  
LAUREL, MONTANA U.S.A.

**INTELLI-GRIP VACUUM CONTROL SYSTEM**

**VACUUM PUMP ASSEMBLY WIRING SCHEMATIC**

D712A-W01 [A-W02]

MRT

WIRE LEGEND: CONTROLLED BY WIRING SYMBOLS DRAWING EXCEPT AS NOTED AND BELOW.	DATE: 12/20/2022
LINE STYLES AND WIDTHS FOR WIRE UNLESS NOTED OTHERWISE:	PRODUCT MANAGER: MARTY P.
N/A ..... 24AWG	CHECKED: MAP
..... 22AWG	APPROVED:
..... 20AWG	
..... 18AWG	
..... 16AWG	
..... 14AWG	
..... 12AWG	
..... 10AWG	
..... 8AWG	
..... 6AWG	
..... 4AWG	
..... 2AWG	
..... 0000	
..... CAT5	

SIZE: <b>A</b>	SCALE: <b>NONE</b>	REVISION: <b>03.B</b>	ECN NUMBER: <b>01/11/2023</b>	ECN BY: <b>MAP</b>	EST. WEIGHT: <b>N/A</b>
----------------	--------------------	-----------------------	-------------------------------	--------------------	-------------------------

8	RED
13	BLK/WHT
5	YEL
7	PNK
2	BLU
10	ORN
4	GRN
11	PRP
12	LIM
6	GRY
3	WHT
9	BLK
14	BRN/WHT
1	BRN

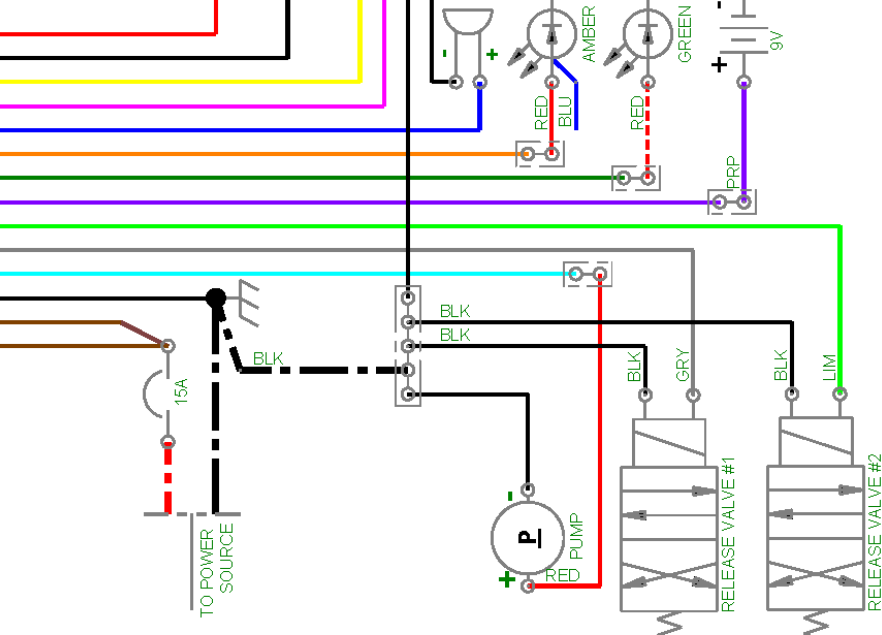

RELEASED FOR PRODUCTION  
 BY: \_\_\_\_\_ DATE: \_\_\_\_\_  
 JOB: \_\_\_\_\_

POWER SOURCE: 12V POWER SUPPLY OPTION

POWER SOURCE: 12V BATTERY OPTION

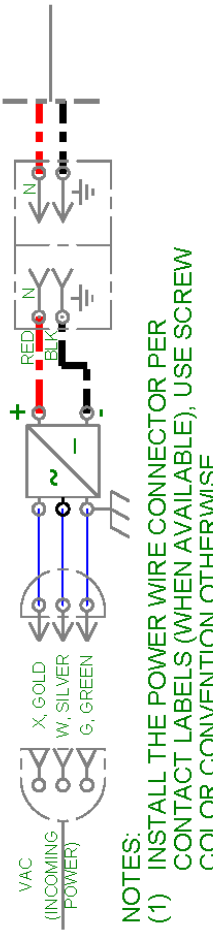

NOTES:  
 (1) INSTALL THE POWER WIRE CONNECTOR PER CONTACT LABELS (WHEN AVAILABLE), USE SCREW COLOR CONVENTION OTHERWISE.

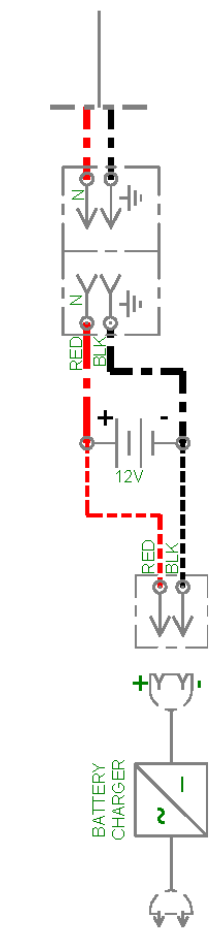

FILE DIRECTORY: 20210802.02.00  
 PROJECT: RD00585L-W01 [W01]  
 THIS DRAWING IS THE PROPERTY OF **WOOD'S POWR-GRIP CO., INC.** LAUREL, MONTANA U.S.A.  
 IT IS LOANED WITH THE UNDERSTANDING THAT NEITHER IT NOR ANY INFORMATION CONTAINED THEREIN WILL BE COPIED, PUBLISHED OR TRANSMITTED TO OTHERS WITHOUT EXPRESS WRITTEN PERMISSION.  
 WPG  
 PRODUCTION LINE FILTER FOR ERGONOMICS AND HIGH CYCLES  
 N/A  
 WIRING SCHEMATIC  
 SO87375-01-W01 [W01]  
 SIZE: A NONE  
 SCALE: 00.E  
 REVISION: VER 00.D  
 ECN NUMBER: 2/12/2024  
 ECN BY: DM  
 EST. WEIGHT: N/A

WIRE LEGEND: CONTROLLED BY WIRING SYMBOLS DRAWING EXCEPT AS NOTED AND BELOW.  
 LINE STYLES AND WIDTHS FOR WIRE UNLESS NOTED OTHERWISE:  
 ..... 20AWG ..... N/A ..... 18AWG  
 ..... 10AWG ..... 12AWG ..... 16AWG ..... 14AWG  
 PRODUCT MANAGER: DANIEL M.  
 DATE: 1/11/2023  
 CHECKED:  
 APPROVED:

NOTES:  
 (1) INSTALL THE POWER WIRE CONNECTOR PER CONTACT LABELS (WHEN AVAILABLE), USE SCREW COLOR CONVENTION OTHERWISE.

